

ERTEK CAM-VİTRAY

Vinç-Çerçeve-Ayna-Vantus-Cam Çeşitleri-Vitray Uygulama

www.ertekcam.com

Vinc Kiralama Hizmetleri

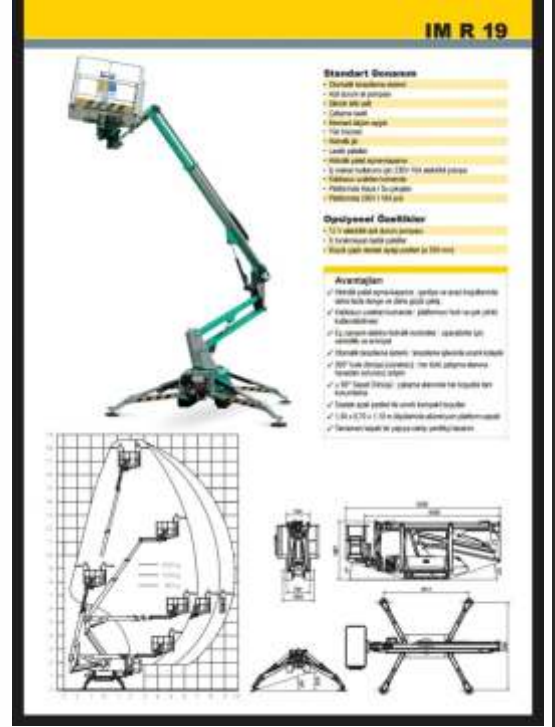

Vinç Kiralama Hizmetleri



Faaliyet Ve Uygulama Alanlarımız

- **Düz ve şekilli, rodajlı / bizoteli cam ve aynalar**
- **Dekoratif camlar**
 - Desenli kumlamalı camlar
 - Dekoratif boyalı camlar
 - Antik camlar
 - Özel tasarım camlar
 - Refrekte camlar
 - Lamine ve dekoratif lamine camlar
 - İşlemeli camlar
 - Dekoratif aynalar
- **Cam üzerine özel tasarım mimari projeler**
- **Cam kapı, cam masa ve cam sehpa çeşitleri**
 - Menteşeli camlar
 - Raf ve vitrin camları
- **Temperli camlar**
 - Güvenlik camları
- **Flexi vitray**
 - Evler, villalar, cafe, bar, restoran, iş yerleri, ofisler, tavan uygulamaları, masa, kapı ve sehpa cam uygulamaları, duvar uygulamaları, panolar ve tabelalar vs... Ayrıca Ahşap (sunta,mdf vb), Mermer vb. bir çok alanda uygulaması yapılabilir.

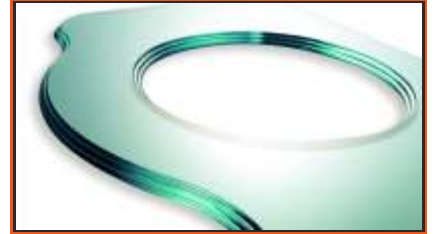



ERTEK CAM-VİTRAY

Vinc-Çerçeve-Ayna-Vantus-Cam Çeşitleri-Vitray Uygulama

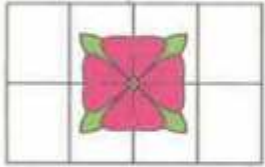

RSG 01

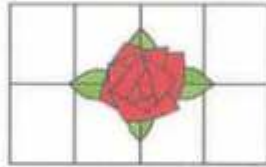

RSG 02

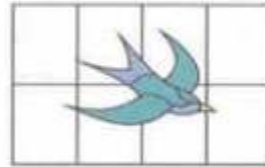

RSG 03

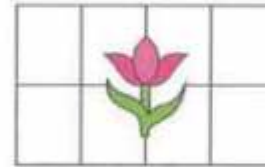

RSG 04

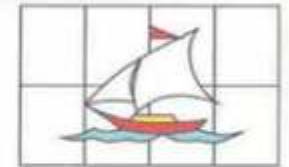

RSG 05

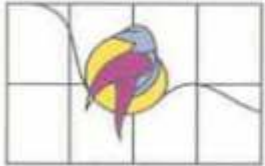

RSG 06

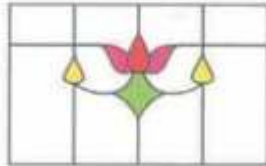

RSG 07

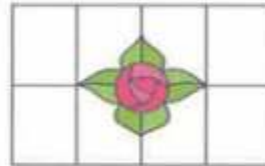

RSG 08

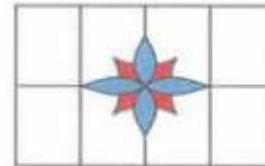

RSG 09

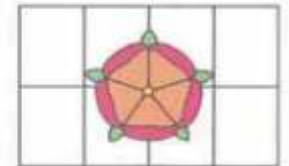

RSG 10

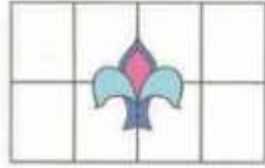

RSG 11

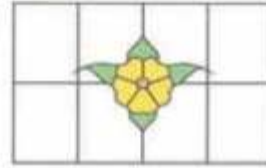

RSG 12

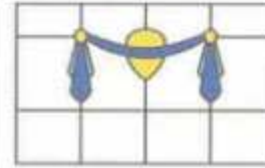

RSG 13

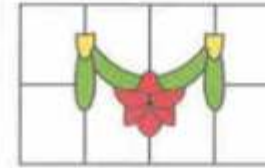

RSG 14



RSG 15

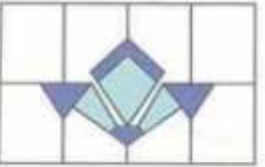

RSG 16

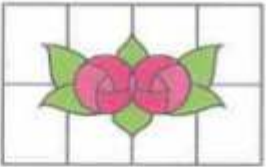

RSG 17

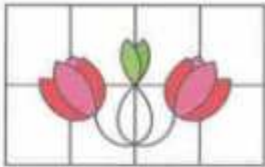

RSG 18

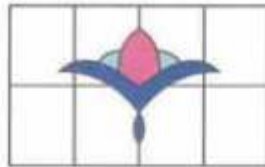

RSG 19

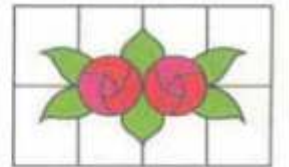

RSG 20

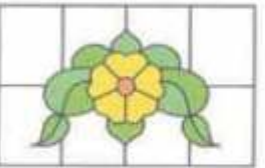

RSG 21

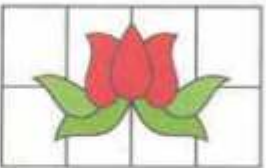

RSG 22

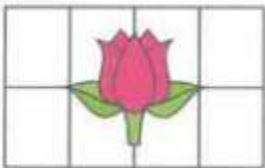

RSG 23

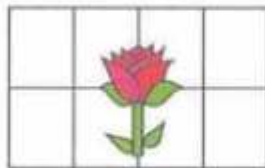

RSG 24

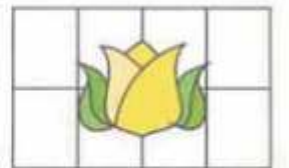

RSG 25

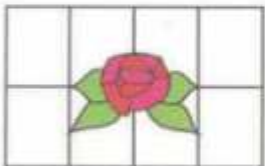

RSG 26

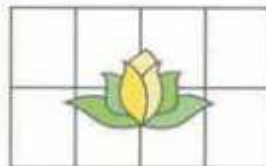

RSG 27

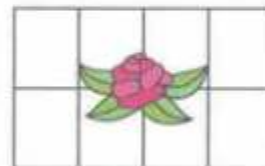

RSG 28

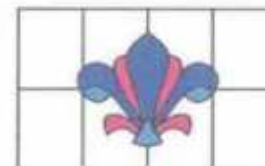

RSG 29

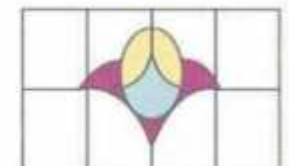

RSG 30



ERTEK CAM-VİTRAY

Vinc-Çerçeve-Ayna-Vantus-Cam Çeşitleri-Vitray Uygulama



RSG 31

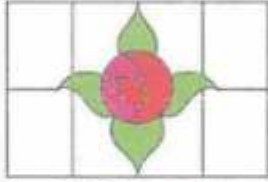

RSG 32

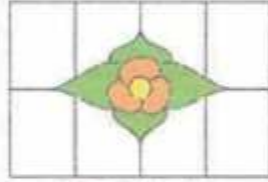

RSG 33

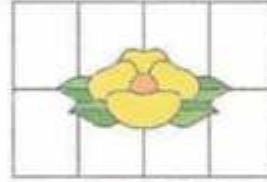

RSG 34

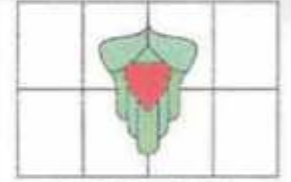

RSG 35

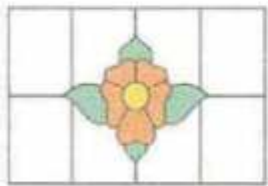

RSG 36

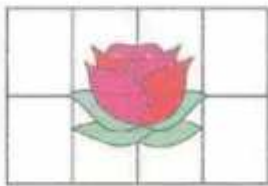

RSG 37

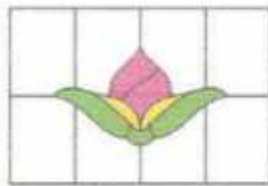

RSG 38



RSG 39

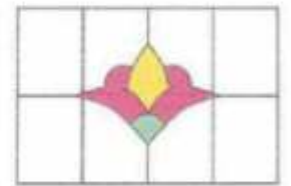

RSG 40

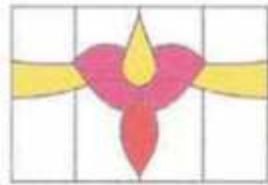

RSG 41

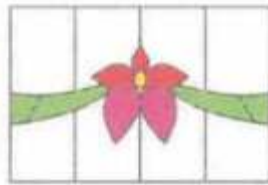

RSG 42

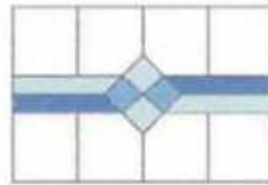

RSG 43

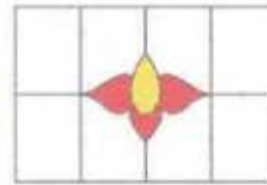

RSG 44

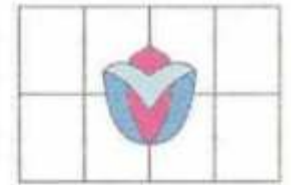

RSG 45

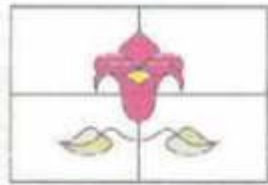

RSG 46

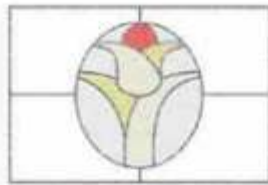

RSG 47

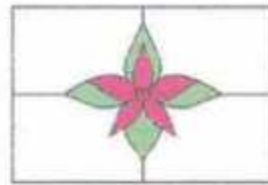

RSG 48

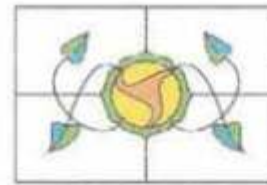

RSG 49

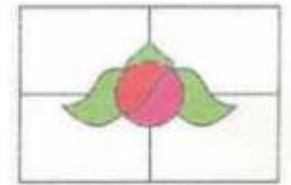

RSG 50

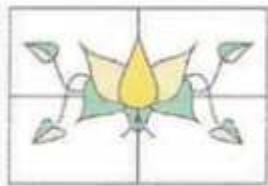

RSG 51

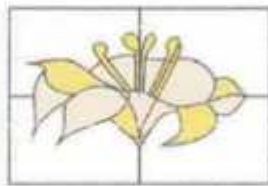

RSG 52



RSG 53

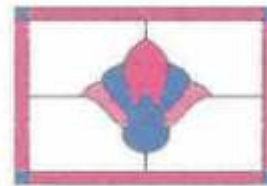

RSG 54

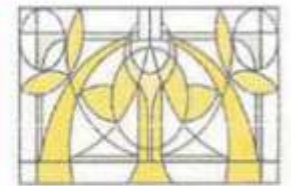

RSG 55

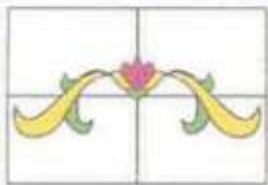

RSG 56

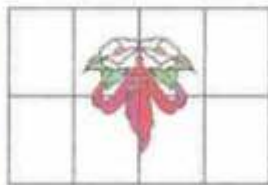

RSG 57



RSG 58

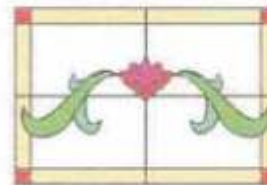

RSG 59

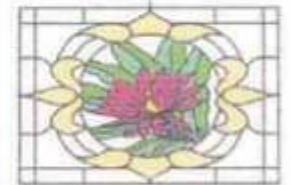

RSG 60

www.ertekcam.com



ERTEK CAM-VİTRAY

Vinc-Çerçeve-Ayna-Vantus-Cam Çeşitleri-Vitray Uygulama

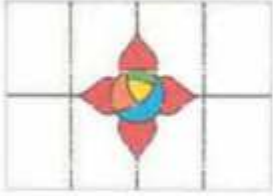

RSG 61

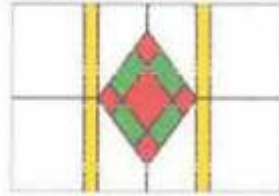

RSG 62

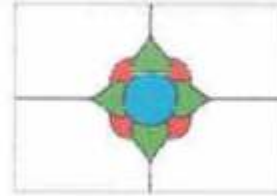

RSG 63

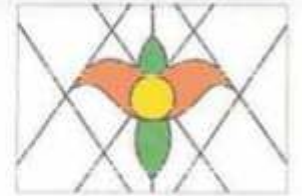

RSG 64

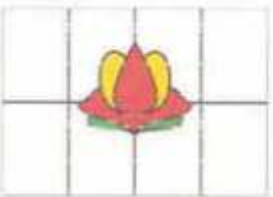

RSG 65

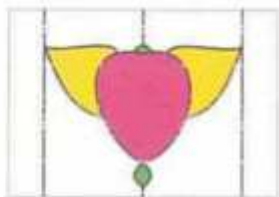

RSG 66



RSG 67

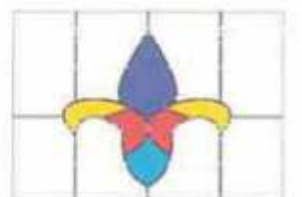

RSG 68

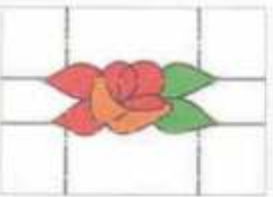

RSG 69



RSG 70



RSG 71



RSG 72



RSG 73

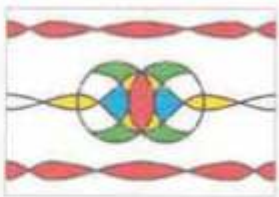

RSG 74



RSG 75

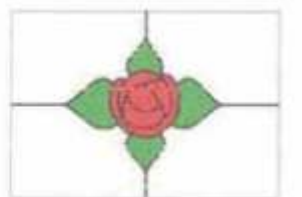

RSG 76

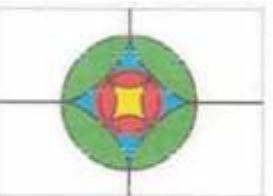

RSG 77

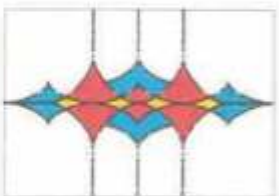

RSG 78

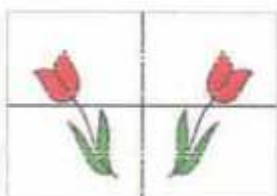

RSG 79

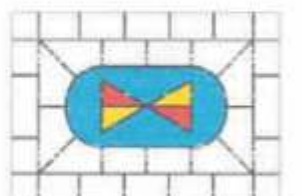

RSG 80



ERTEK CAM-VİTRAY

Vinç-Çerçeve-Ayna-Vantus-Cam Çeşitleri-Vitray Uygulama

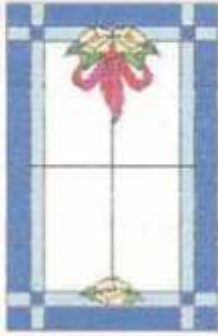

RSG DPU1

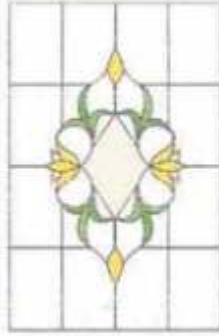

RSG DPU2

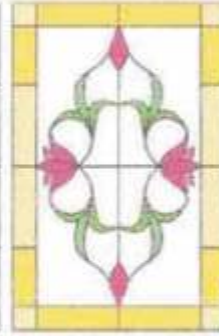

RSG DPU3

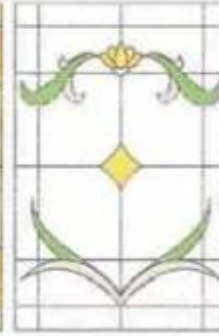

RSG DPU4

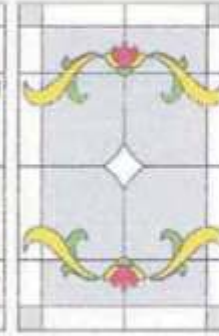

RSG DPU5



RSG DP06



RSG DP07

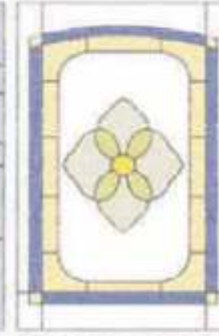

RSG DP08

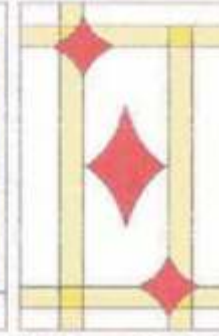

RSG DP09



RSG DP10



RSG DP11

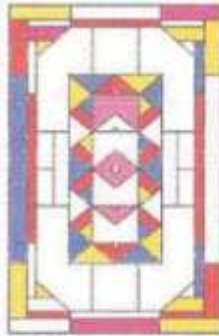

RSG DP12

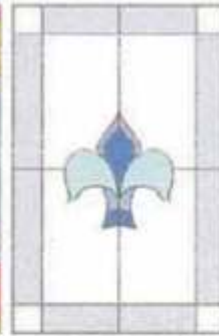

RSG DP13

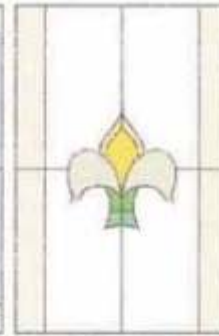

RSG DP14



RSG DP15

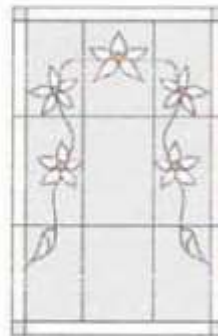

RSG DP16



RSG DP17

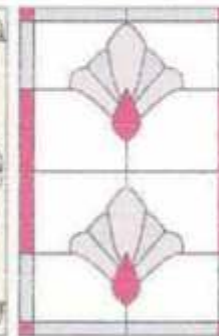

RSG DP18



RSG DP19



RSG DP20

www.ertekcam.com



ERTEK CAM-VİTRAY

Vinç-Çerçeve-Ayna-Vantus-Cam Çeşitleri-Vitray Uygulama

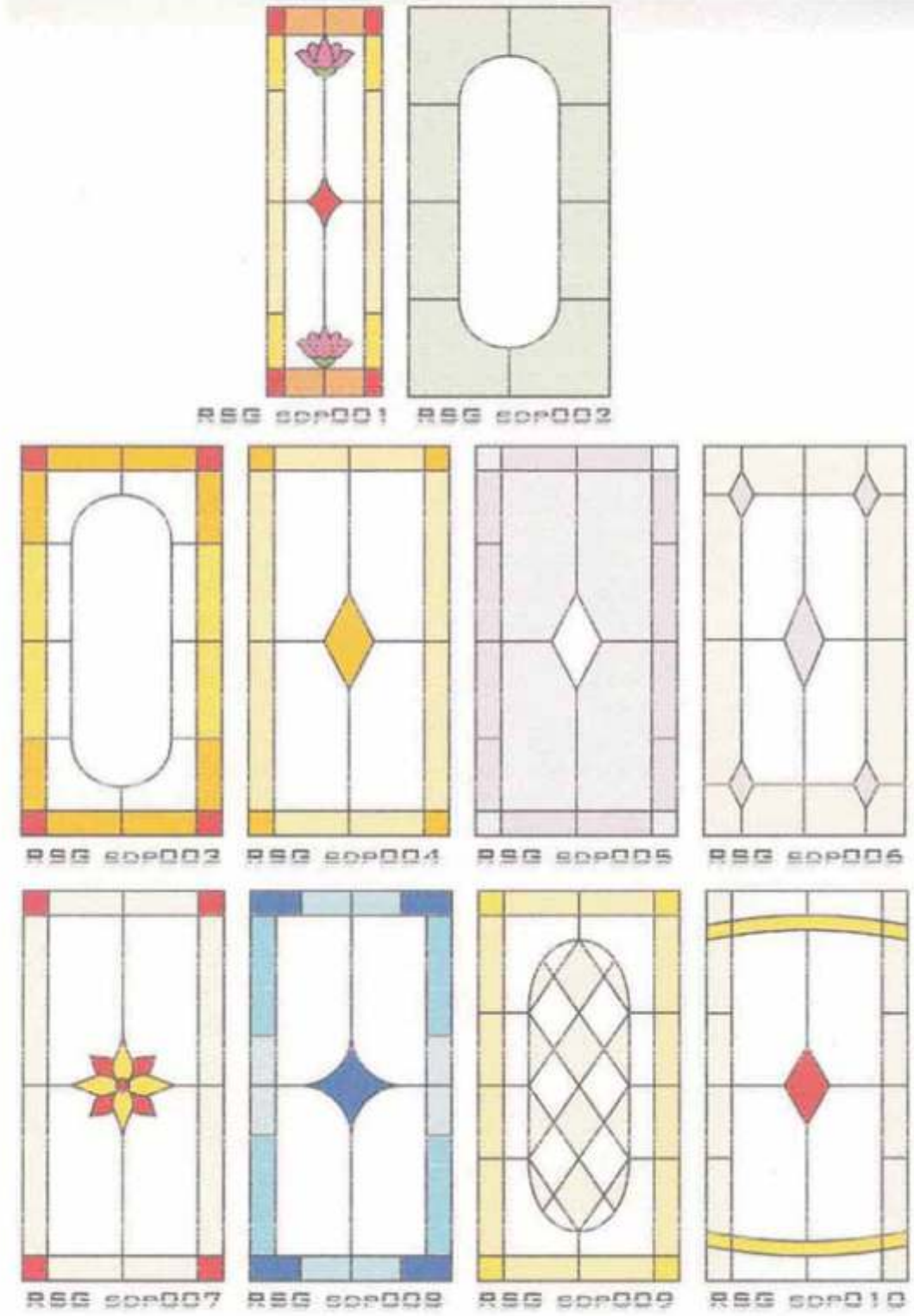

www.ertekcam.com



ERTEK CAM-VİTRAY

Vinc-Çerçeve-Ayna-Vantus-Cam Çeşitleri-Vitray Uygulama

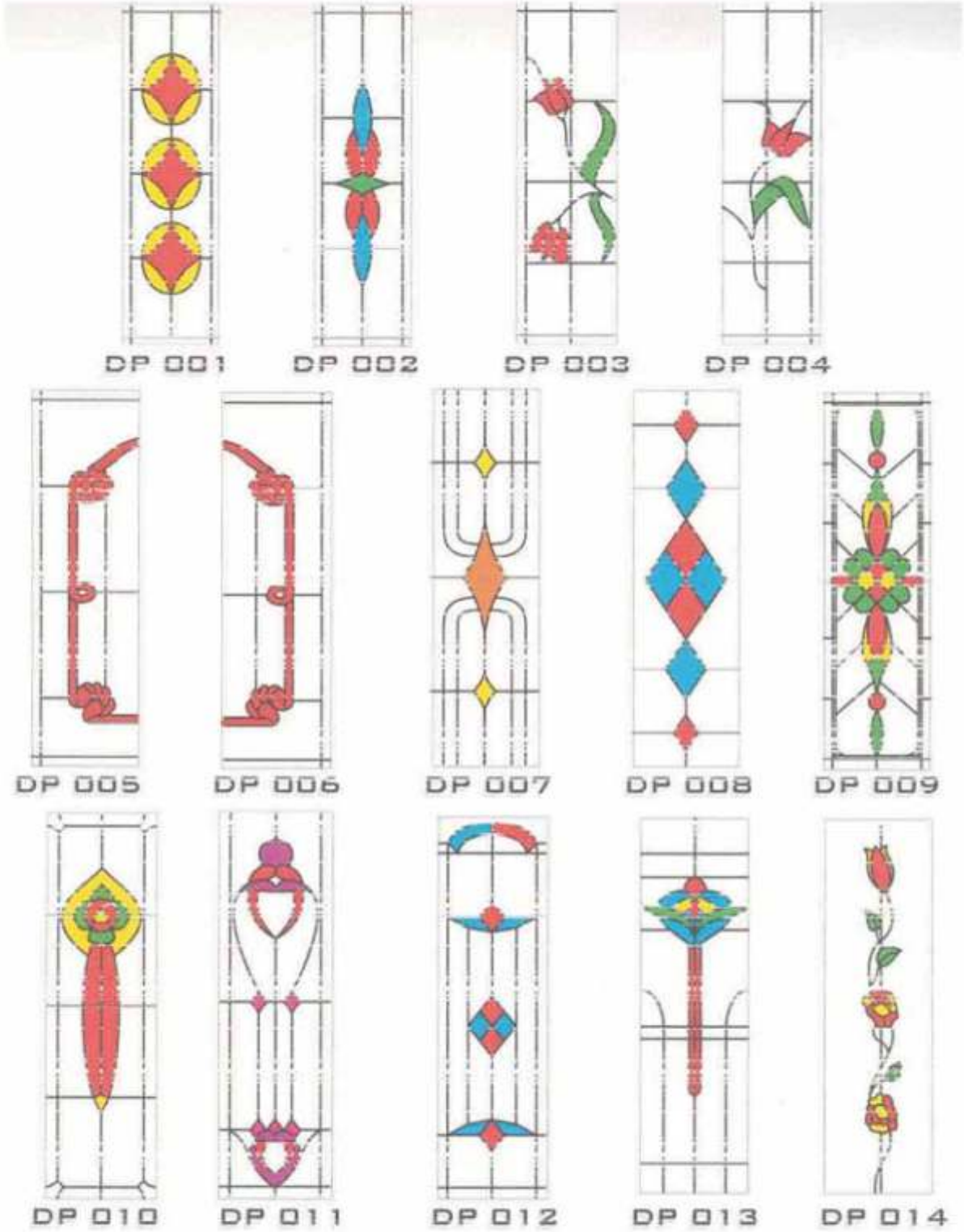

www.ertekcam.com



ERTEK CAM-VİTRAY

Vinc-Çerçeve-Ayna-Vantus-Cam Çeşitleri-Vitray Uygulama

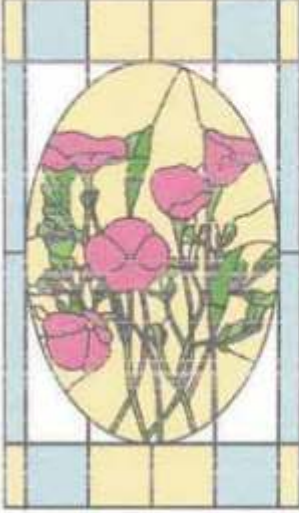

RSG SGP001



RSG SGP002



RSG SGP003

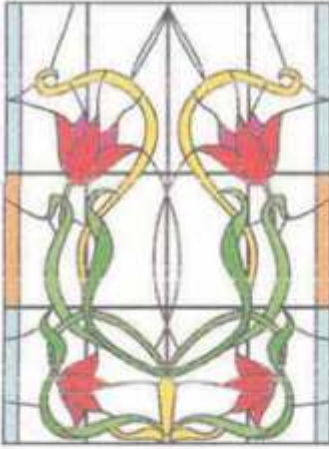

RSG SGP004

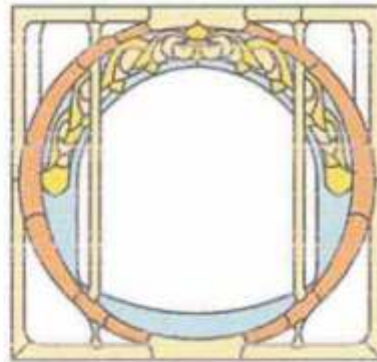

RSG SGP005



RSG SGP006

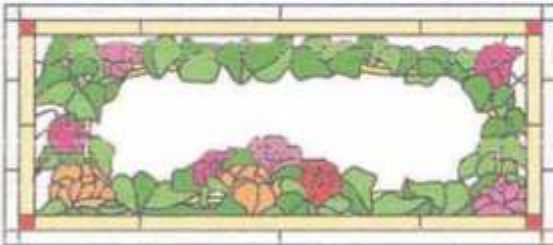

RSG SGP008

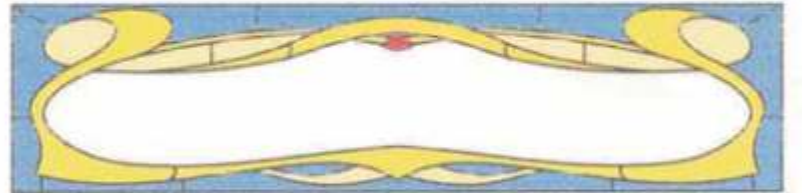

RSG SGP007

www.ertekcam.com



ERTEK CAM-VITRAY

Vinç-Çerçeve-Ayna-Vantus-Cam Çeşitleri-Vitray Uygulama



CHARLIE CHAPLIN



DES DAMES



GALLEON



BALLOON LADY



JAPANESE LADY



DANCING COUPLE

www.ertekcam.com



ERTEK CAM-VİTRAY

Vinc-Çerçeve-Ayna-Vantus-Cam Çeşitleri-Vitrav Uygulama



RSG Ex001



RSG Ex002



RSG Ex003



RSG Ex004



RSG Ex005

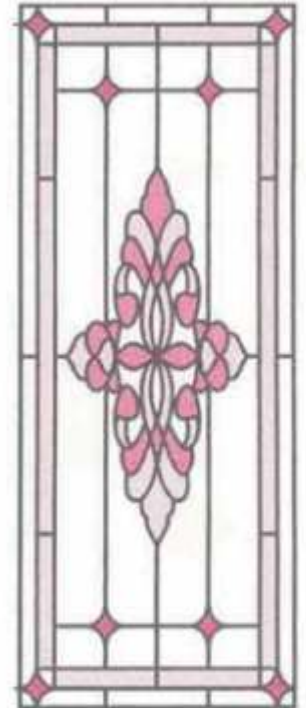

RSG Ex006



ERTEK CAM-VİTRAY

Vinc-Çerçeve-Ayna-Vantus-Cam Çeşitleri-Vitray Uygulama



W-01

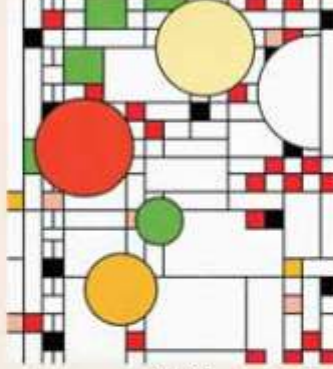

W-02



W-03



W-04



W-05

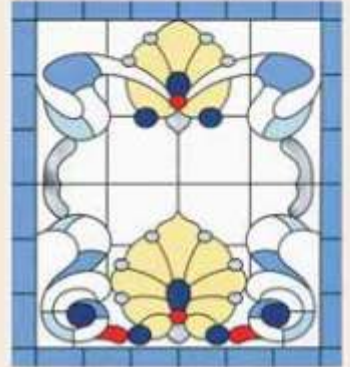

W-06



W-07



W-08



W-09



W-10

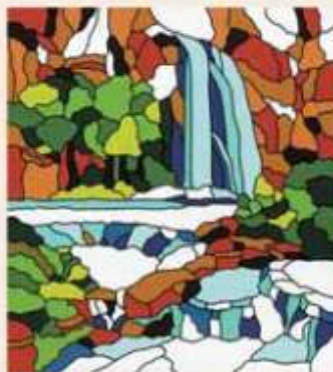

W-11



W-12



ERTEK CAM-VİTRAY

Vinc-Çerçeve-Ayna-Vantus-Cam Çeşitleri-Vitray Uygulama



W-13



W-14



W-15



W-16



W-17



W-18



W-19



W-20



W-21



W-22



W-23

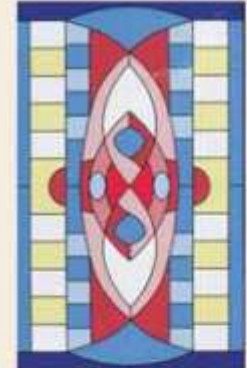

W-24



W-25



W-26



W-27



W-28



ERTEK CAM-VİTRAY

Vinc-Çerçeve-Ayna-Vantus-Cam Çeşitleri-Vitray Uygulama



W-29



W-30



W-31



W-32



W-33



W-34



Ka-01



Ka-02



Ka-03



Ka-04



Ka-05



Ka-06



ERTEK CAM-VİTRAY

Vinc-Çerçeve-Ayna-Vantus-Cam Çeşitleri-Vitray Uygulama



Ka-07



Ka-08



Ka-09



Ka-10



Ka-11



Ka-12



Ka-13



Ka-14



Ka-15



Ka-16



Ka-17



Ka-18



ERTEK CAM-VİTRAY

Vinc-Çerçeve-Ayna-Vantus-Cam Çeşitleri-Vitray Uygulama



A-01



A-02



A-03



A-04



A-05



A-06



A-07



A-08



A-09



A-10



A-11



A-12



A-13



A-14



A-15



A-16



A-17



A-18



ERTEK CAM-VİTRAY

Vinc-Çerçeve-Ayna-Vantus-Cam Çeşitleri-Vitray Uygulama



A-19



A-20

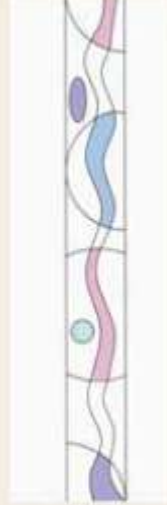

A-21



A-22



A-23



A-24



A-25



A-26



A-27



A-28



A-29



A-30



C101



C102

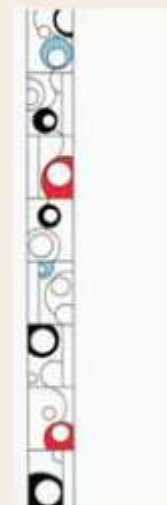

C103



C104



C105



C106



ERTEK CAM-VİTRAY

Vinc-Çerçeve-Ayna-Vantus-Cam Çeşitleri-Vitray Uygulama



C107



C108



C109



C110



C111



C112



C113



C114



C115

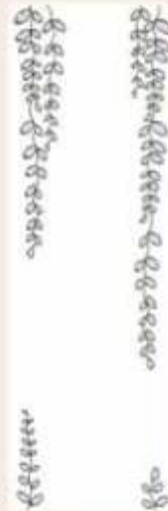

C116



C117



C118



C-119



C120



C121



C122



C123



C124



ERTEK CAM-VİTRAY

Vinci-Çerçeve-Ayna-Vantus-Cam Çeşitleri-Vitray Uygulama



C125



C126



C127



C128



C129



C130



C131



C132



C133



C134



C135



C136



C137



C138



C139



C140



C141



C142



ERTEK CAM-VİTRAY

Vinc-Çerçeve-Ayna-Vantus-Cam Çeşitleri-Vitray Uygulama



C143



C144



C145



C146



C147



C148



C149



C150



C151



C152



C153



C154



C155



C156



C157



C158



C159



C160

www.ertekcam.com



ERTEK CAM-VİTRAY

Vinc-Çerçeve-Ayna-Vantus-Cam Çeşitleri-Vitray Uygulama



C161



C162



C163



C164



C165



C166



C167

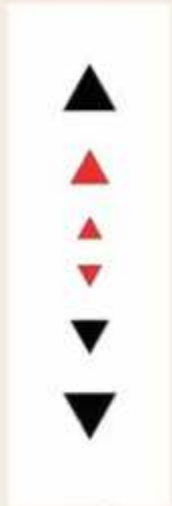

C168



C169



C170



C171



C172



C173



C174



C175



C176



C177



C178



ERTEK CAM-VİTRAY

Vinc-Çerçeve-Ayna-Vantus-Cam Çeşitleri-Vitray Uygulama



C179



C180



C181



C182



C183



C184

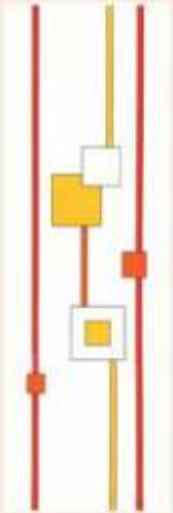

C185



C186



C187



C188



C189

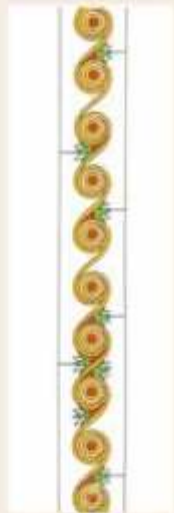

C190



C191



C192



C193



C194



C195



C196



ERTEK CAM-VİTRAY

Vinc-Çerçeve-Ayna-Vantus-Cam Çeşitleri-Vitray Uygulama



C197



C198



C199

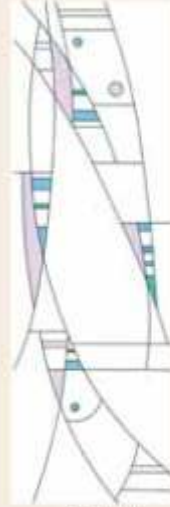

C1100



C1101



C1102



C1103



C1104



C1105



C1106



C1107



C1108

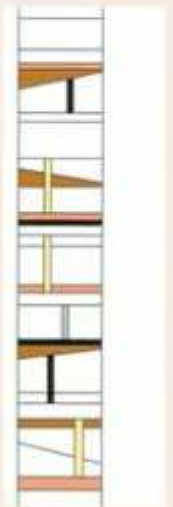

C1109



C1110

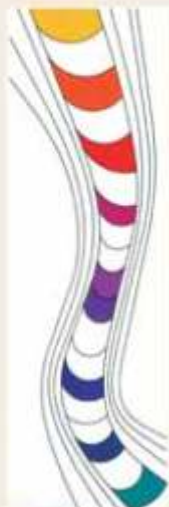

C1111

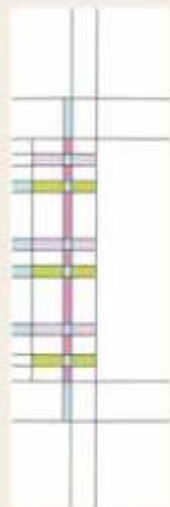

C1112

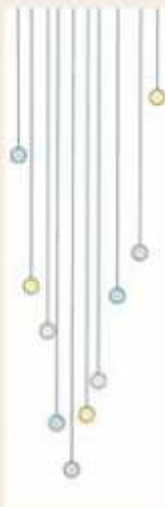

C1113



C1114

www.ertekcam.com



ERTEK CAM-VİTRAY

Vinci-Çerçeve-Ayna-Vantus-Cam Çeşitleri-Vitray Uygulama

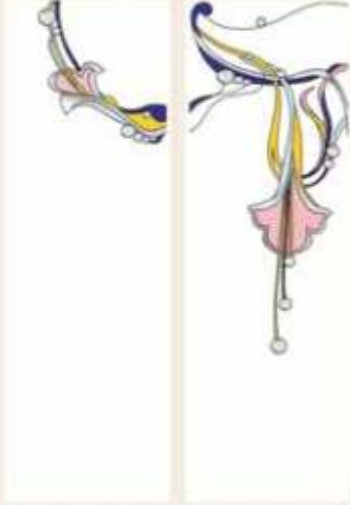

C201

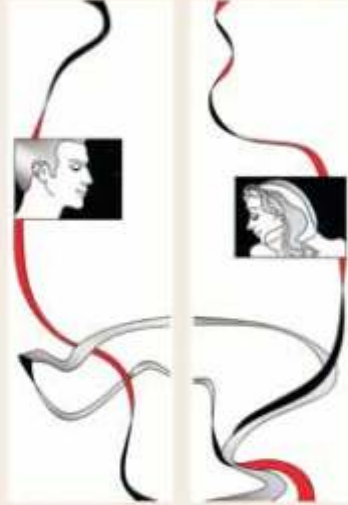

C202



C203

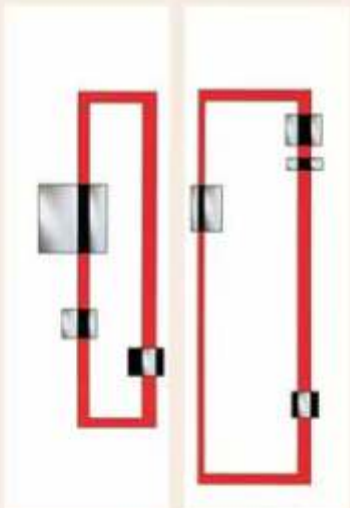

C204



C205



C206

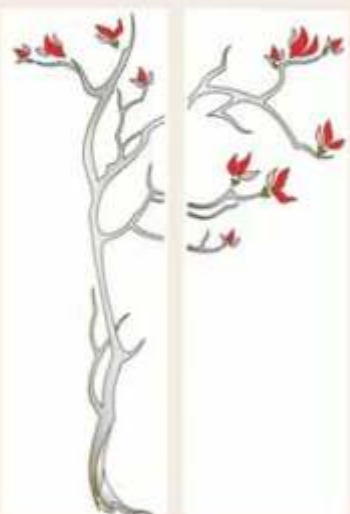

C207



C208



C209



ERTEK CAM-VİTRAY

Vinc-Çerçeve-Ayna-Vantus-Cam Çeşitleri-Vitray Uygulama



C210



C211



C212



C213



C214



C215

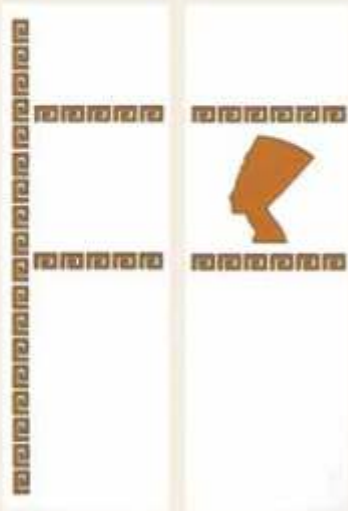

C216



C217

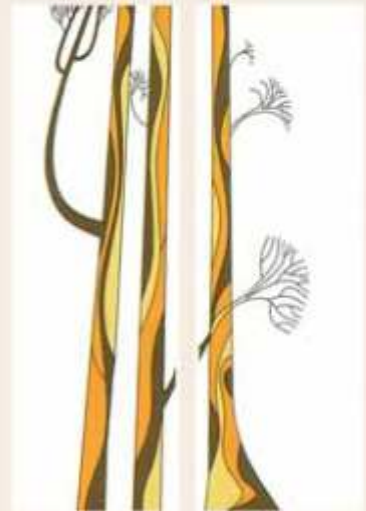

C218



ERTEK CAM-VİTRAY

Vinc-Çerçeve-Ayna-Vantus-Cam Çeşitleri-Vitray Uygulama

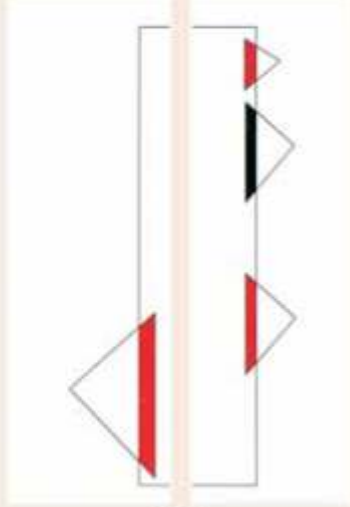

C219

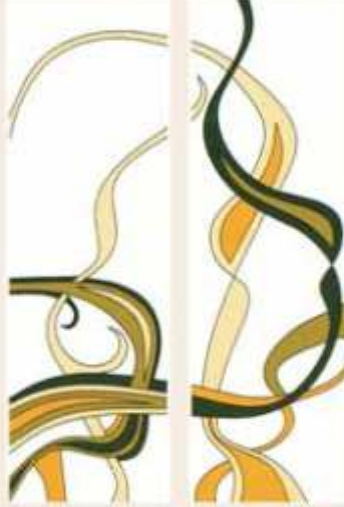

C220

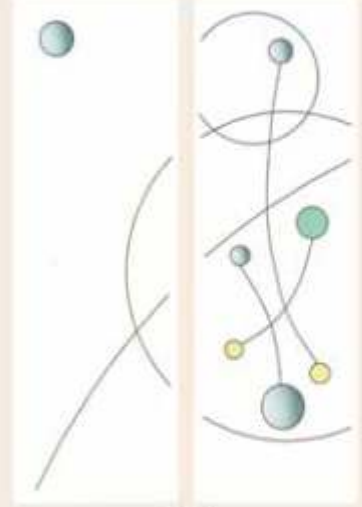

C221



C222

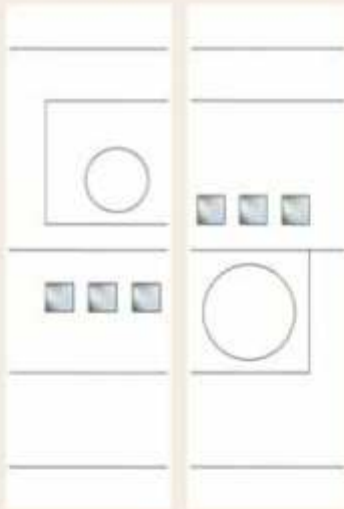

C223

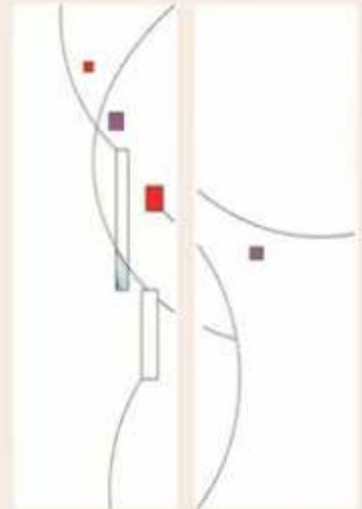

C224

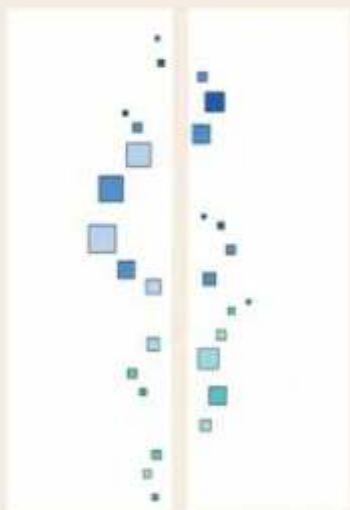

C225



C226

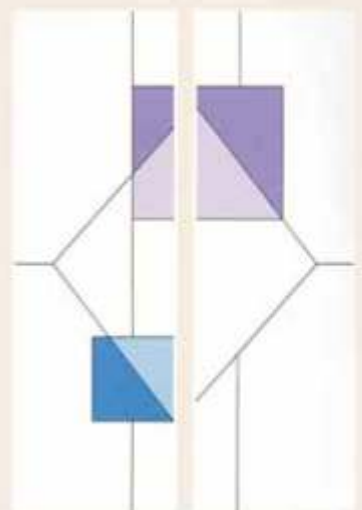

C227



ERTEK CAM-VİTRAY

Vinc-Çerçeve-Ayna-Vantus-Cam Çeşitleri-Vitray Uygulama

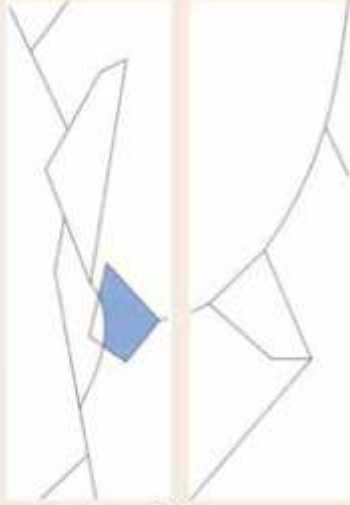

C228



C229

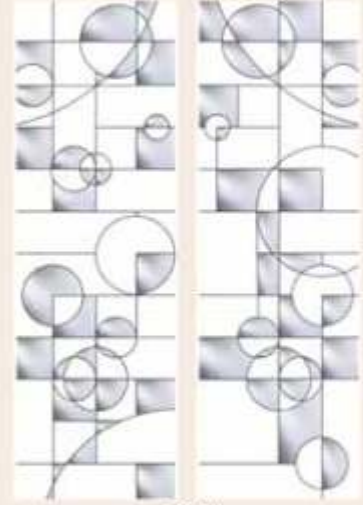

C230



C231



C232



C233

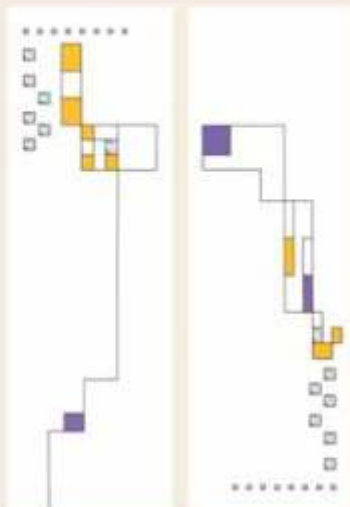

C234

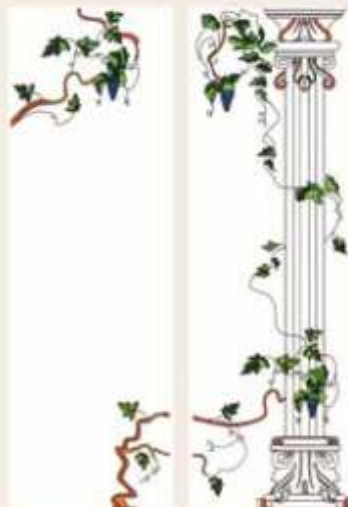

C235



C236



ERTEK CAM-VİTRAY

Vinc-Çerçeve-Ayna-Vantus-Cam Çeşitleri-Vitray Uygulama

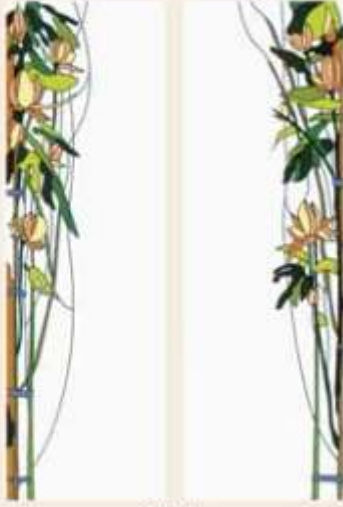

C237



C238



C239



C240



C241



C242

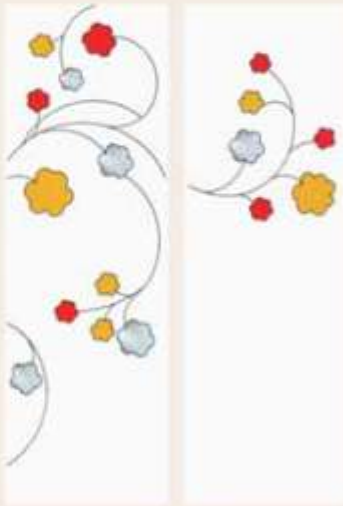

C243



C244



C245



ERTEK CAM-VİTRAY

Vinc-Çerçeve-Ayna-Vantus-Cam Çeşitleri-Vitray Uygulama



C246



C247

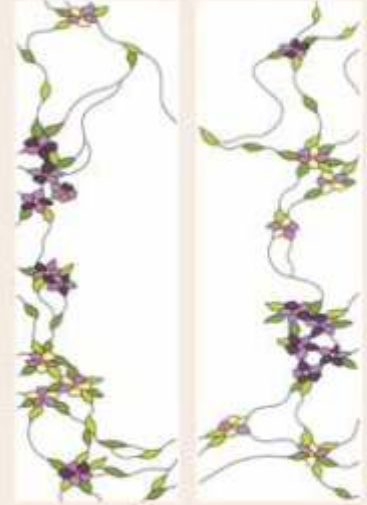

C248



C249



C250



C251



C252



C253

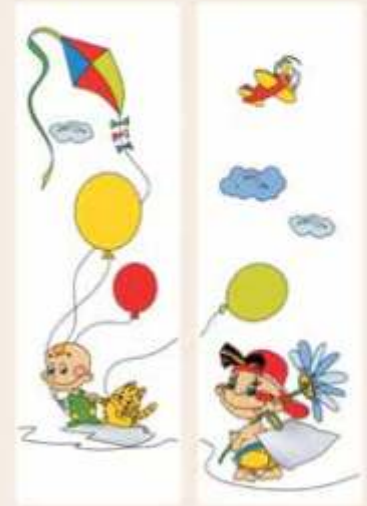

C254



ERTEK CAM-VİTRAY

Vinc-Çerçeve-Ayna-Vantus-Cam Çeşitleri-Vitray Uygulama



C301



C302



C303

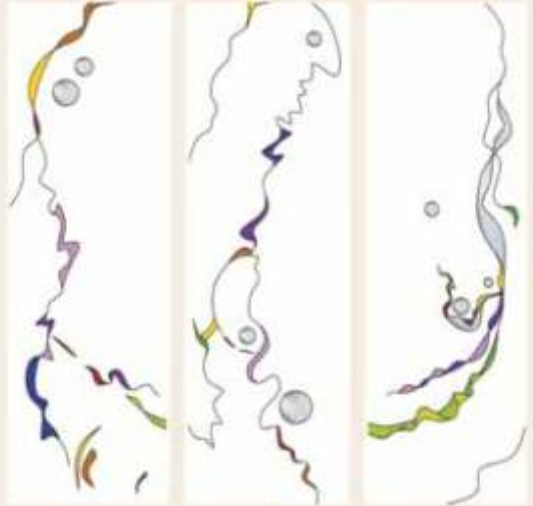

C304

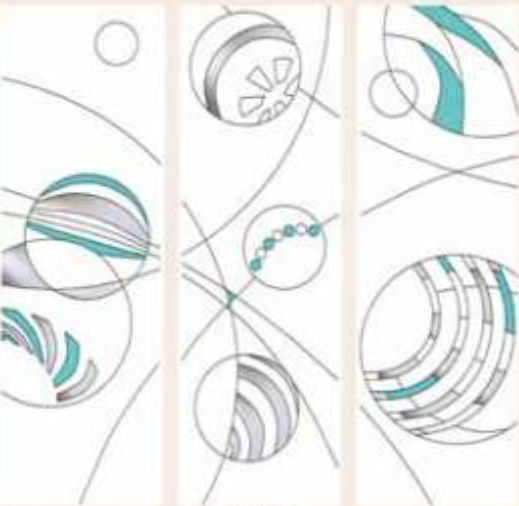

C305



C306



ERTEK CAM-VİTRAY

Vinc-Çerçeve-Ayna-Vantus-Cam Çeşitleri-Vitray Uygulama



C307



C308

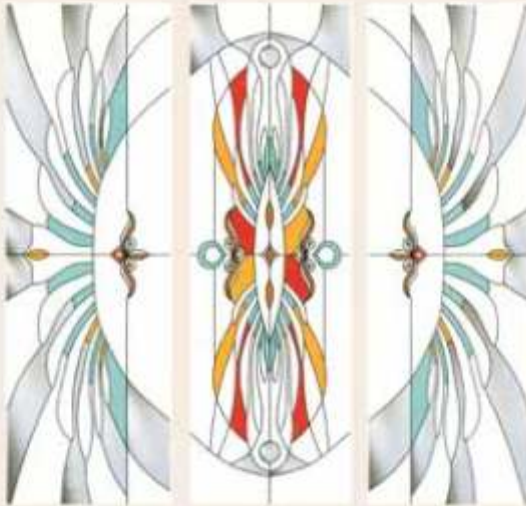

C309

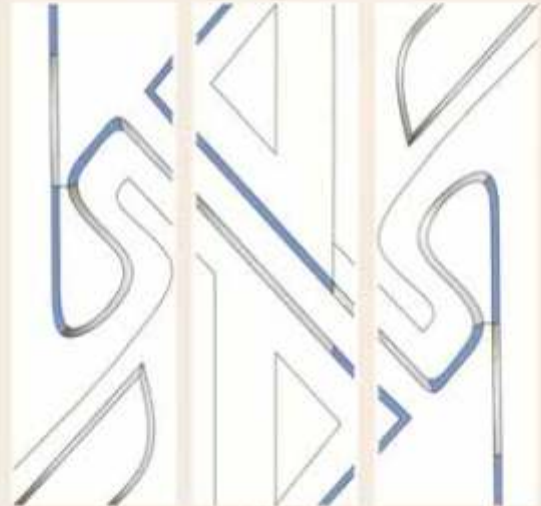

C310



C311



C312



ERTEK CAM-VİTRAY

Vinc-Çerçeve-Ayna-Vantus-Cam Çeşitleri-Vitray Uygulama



C313

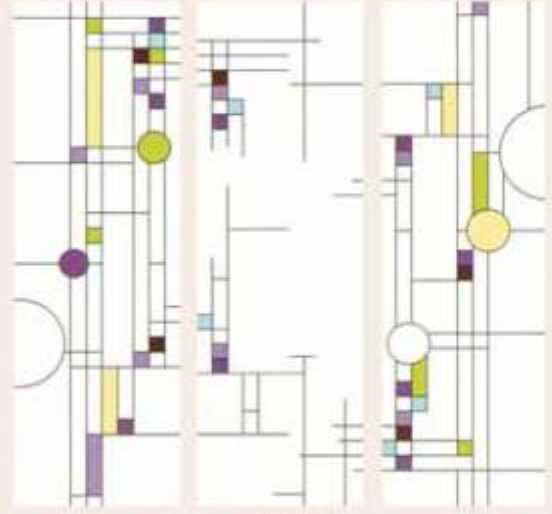

C314



C315



C316



C317

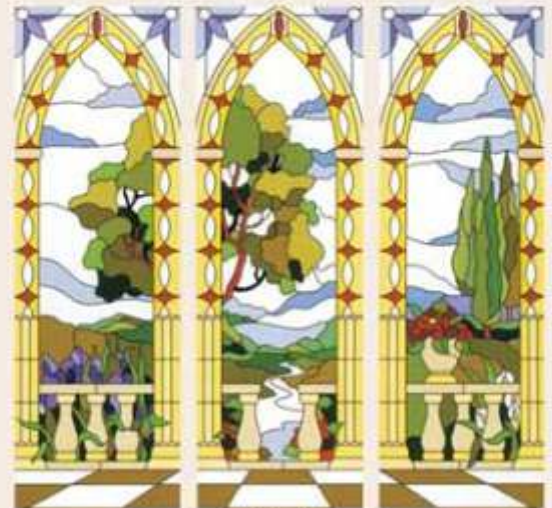

C318



ERTEK CAM-VİTRAY

Vinc-Çerçeve-Ayna-Vantus-Cam Çeşitleri-Vitray Uygulama



C319



C320



C321

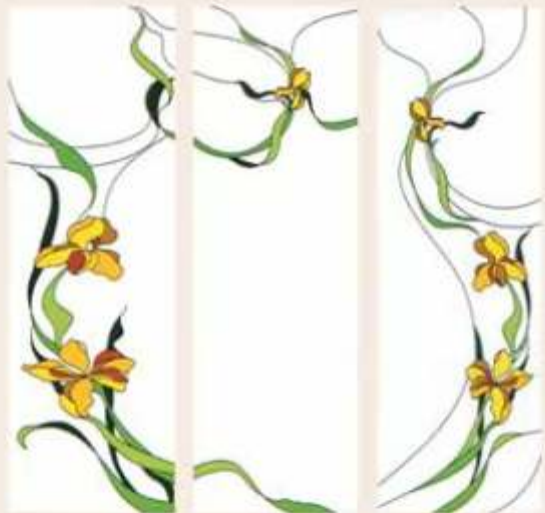

C322

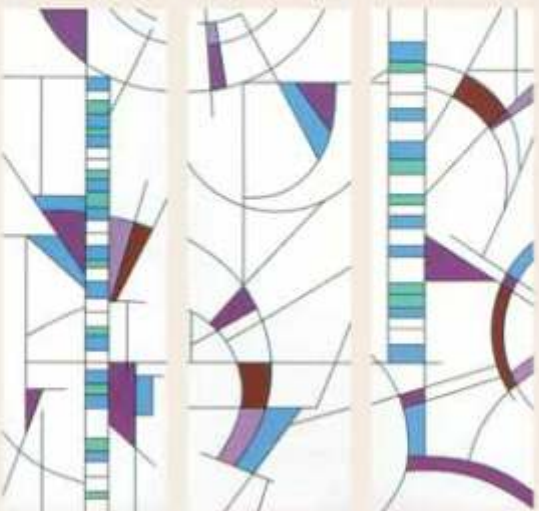

C323



C324



ERTEK CAM-VİTRAY

Vinc-Çerçeve-Ayna-Vantus-Cam Çeşitleri-Vitray Uygulama

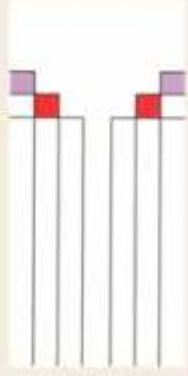

DV-01

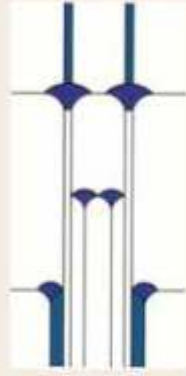

DV-02



DV-03

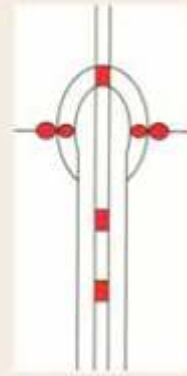

DV-04



DV-05



DV-06

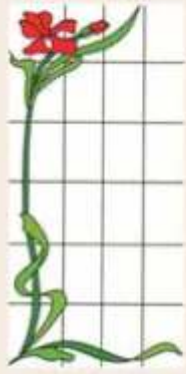

DV-07



DV-08



DV-09

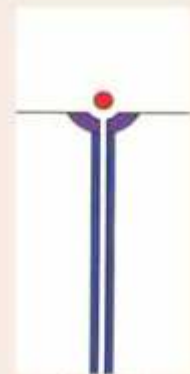

DV-010

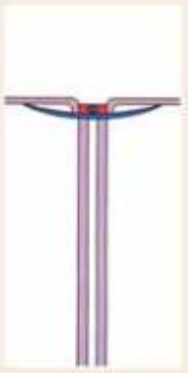

DV-11



DV-12



DV-13

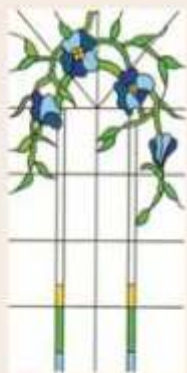

DV-14

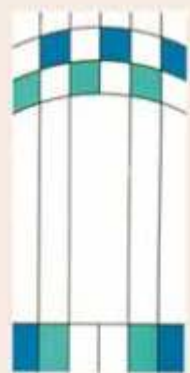

DV-15



DV-16



DV-17



DV-18

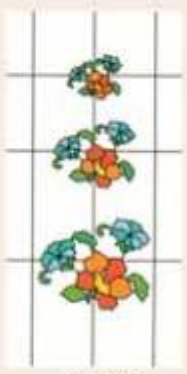

DV-19



DV-20



ERTEK CAM-VİTRAY

Vinc-Çerçeve-Ayna-Vantus-Cam Çeşitleri-Vitray Uygulama



DV-21



DV-22



DV-23



DV-24



DV-25



DV-26



DV-27



DV-28



DV-29



DV-30



DV-31



DV-32



DV-33

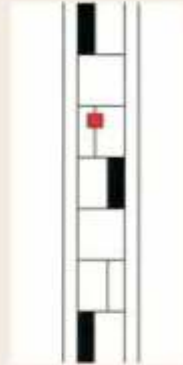

DV-34

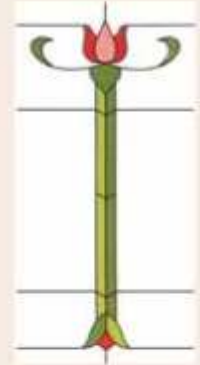

DV-35



DV-36

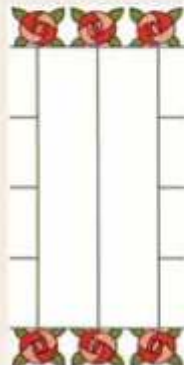

DV-37



DV-38

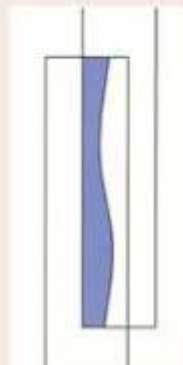

DV-39

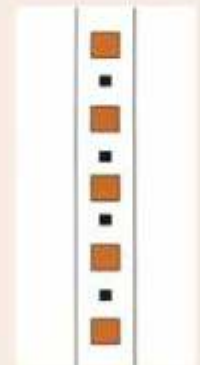

DV-40



ERTEK CAM-VİTRAY

Vinc-Çerçeve-Ayna-Vantus-Cam Çeşitleri-Vitray Uygulama

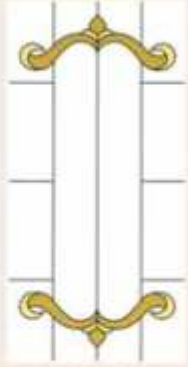

DV-41



DV-42

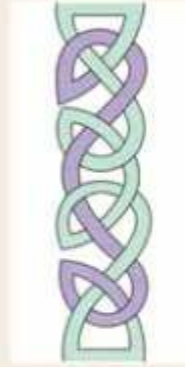

DV-43

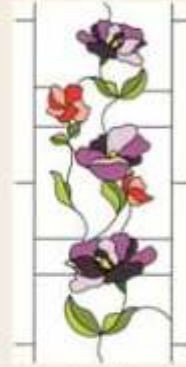

DV-44

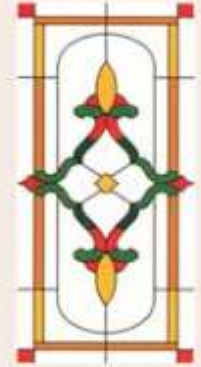

DV-45



DV-46



DV-47



DV-48



DV-49



DV-50



DV-51

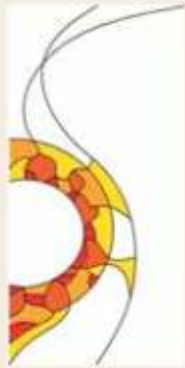

DV-52



DV-53



DV-54



DV-55

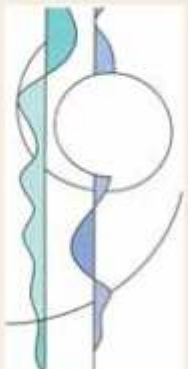

DV-56

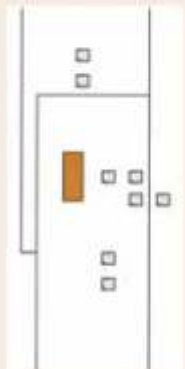

DV-57



DV-58



DV-59

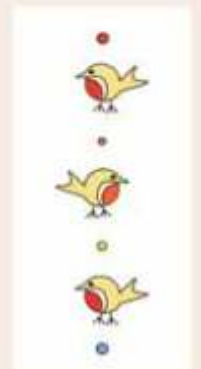

DV-60



ERTEK CAM-VİTRAY

Vinc-Çerçeve-Ayna-Vantus-Cam Çeşitleri-Vitray Uygulama



K-01

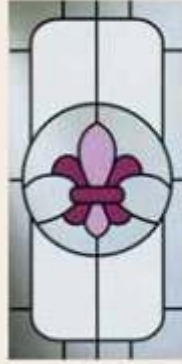

K-02



K-03



K-04

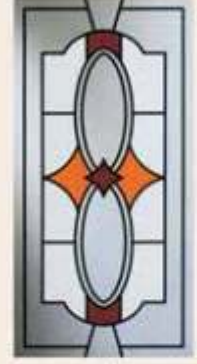

K-05



K-06



K-07



K-08



K-09



K-10



K-11



K-12



K-13



K-14



K-15



K-16



K-17



K-18



K-19



K-20



ERTEK CAM-VİTRAY

Vinc-Çerçeve-Ayna-Vantus-Cam Çeşitleri-Vitray Uygulama

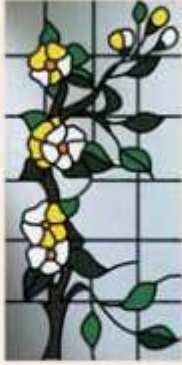

K-21



K-22

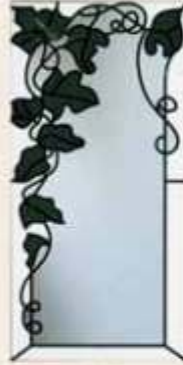

K-23



K-24

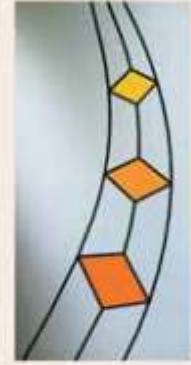

K-25



K-26



K-27



K-28



K-29



K-30



K-31



K-32



K-33

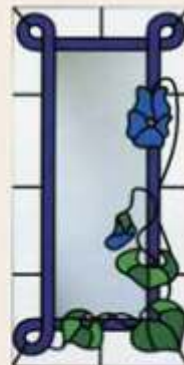

K-34



K-35



K-36

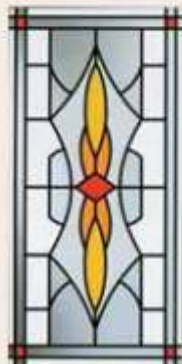

K-37



K-38



K-39



K-40



ERTEK CAM-VİTRAY

Vinc-Çerçeve-Ayna-Vantus-Cam Çeşitleri-Vitray Uygulama

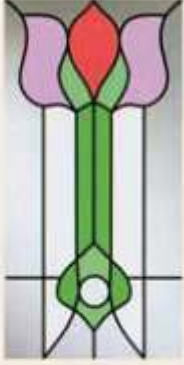

K-41



K-42

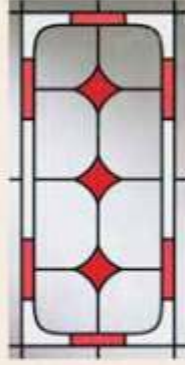

K-43



K-44



K-45

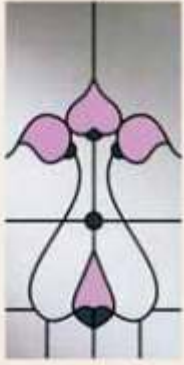

K-46

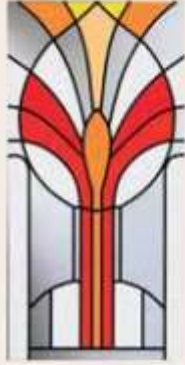

K-47



K-48



K-49



K-50



K-51

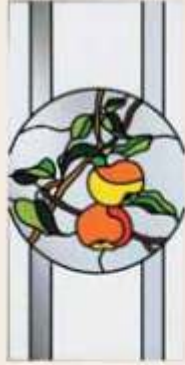

K-52



K-53



K-54

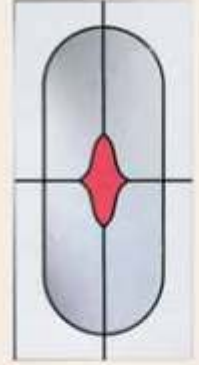

K-55



K-56



K-57

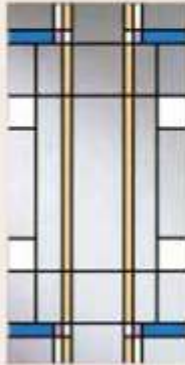

K-58



K-59

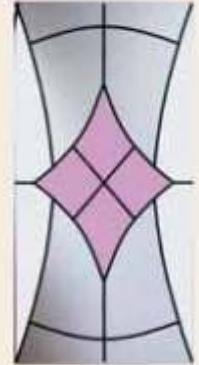

K-60



ERTEK CAM-VİTRAY

Vinci-Çerçeve-Ayna-Vantus-Cam Çeşitleri-Vitrav Uygulama

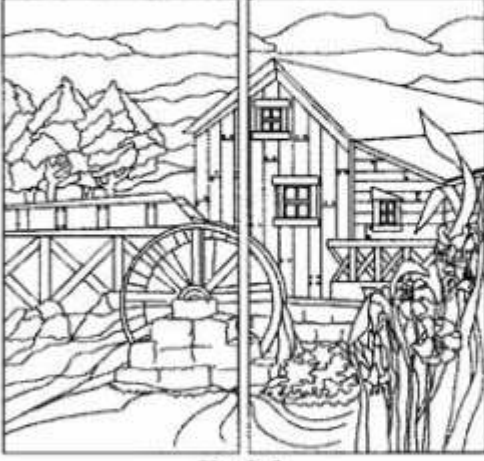

D-01

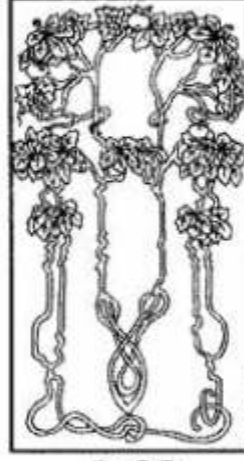

D-02

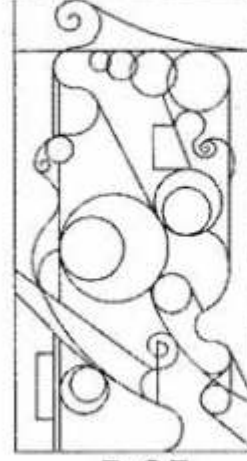

D-03

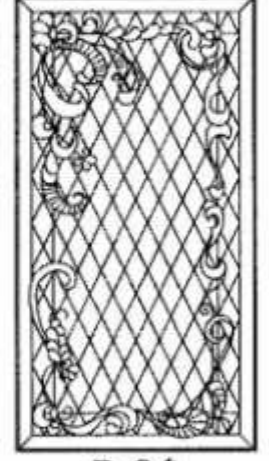

D-04



D-05



D-06



D-07



D-08



D-09

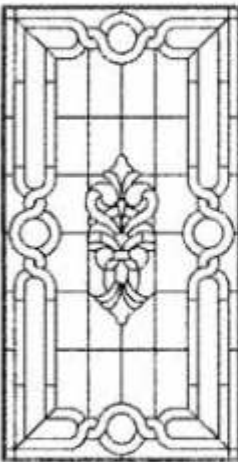

D-10

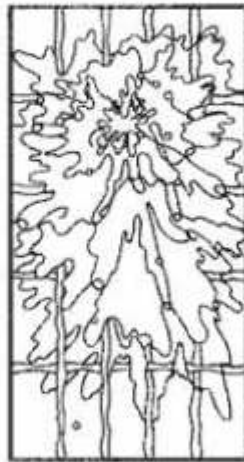

D-11

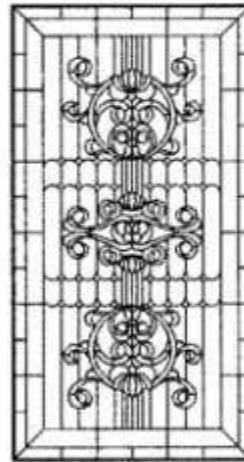

D-12



D-13

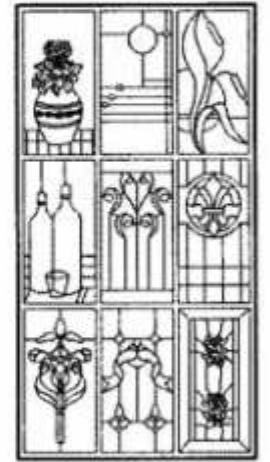

D-14



ERTEK CAM-VİTRAY

Vinc-Çerçeve-Ayna-Vantus-Cam Çeşitleri-Vitray Uygulama

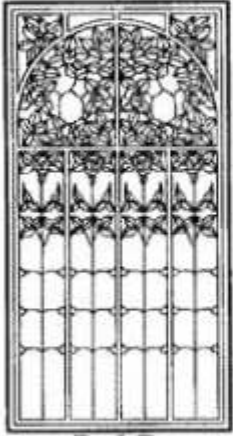

D-15



D-16



D-17

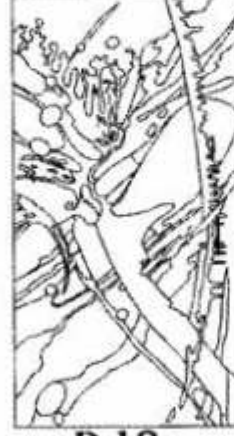

D-18



D-19

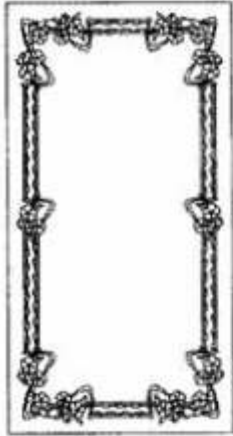

D-20

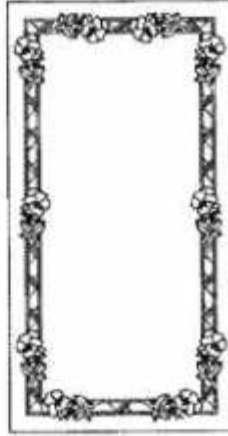

D-21

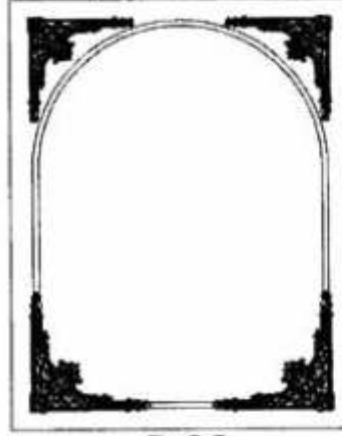

D-22

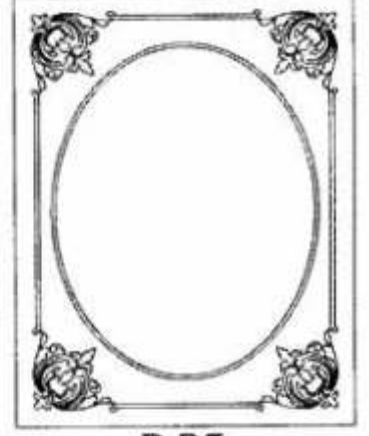

D-23



D-24



D-25



D-26



ERTEK CAM-VİTRAY

Vinc-Çerçeve-Ayna-Vantus-Cam Çeşitleri-Vitrav Uygulama

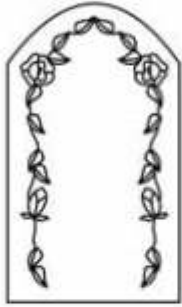

CRD044

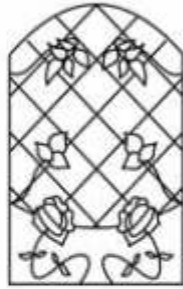

CRD045



CRD046

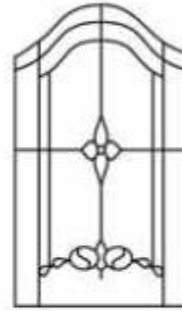

CRD047

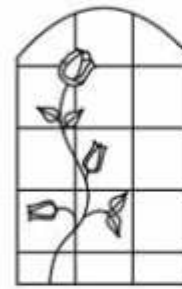

CRD048

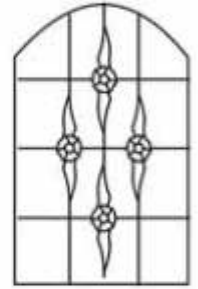

CRD049

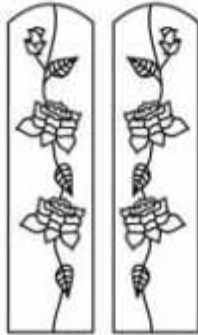

CRD050

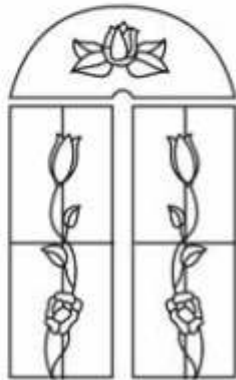

CRD051

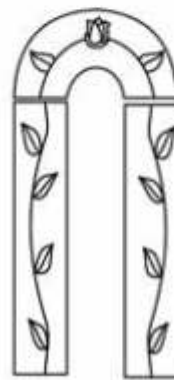

CRD052

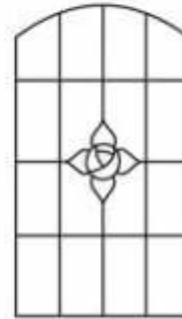

CRD053

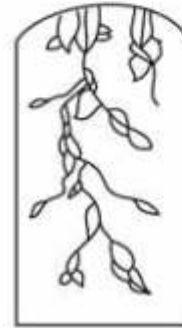

CRD054



CRD055

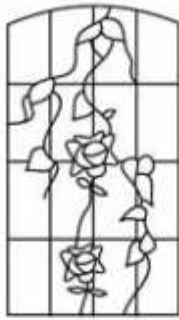

CRD056



CRD057

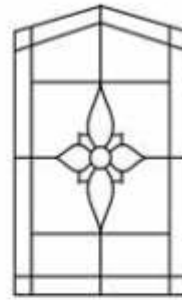

CRD058

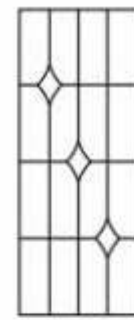

CRD059

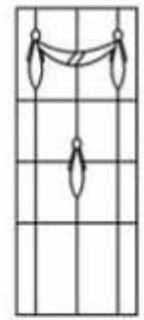

CRD060

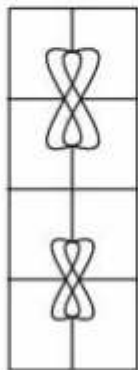

CRD201



CRD202



CRD203



CRD204

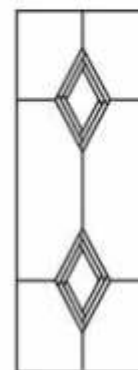

CRD205

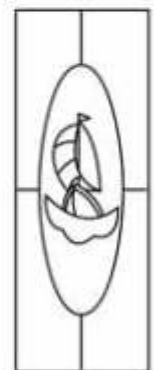

CRD206



ERTEK CAM-VİTRAY

Vinç-Çerçeve-Ayna-Vantus-Cam Çeşitleri-Vitrav Uygulama

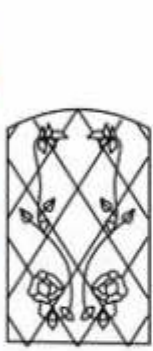

CRD017



CRD018

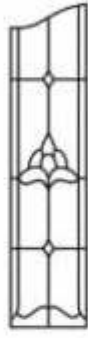

CRD019

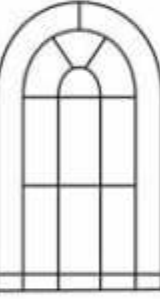

CRD020



CRD021



CRD022

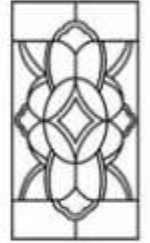

CRD023

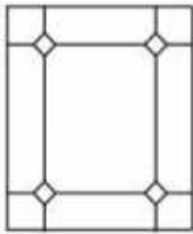

CRD024

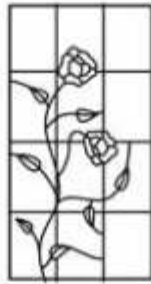

CRD025



CRD026

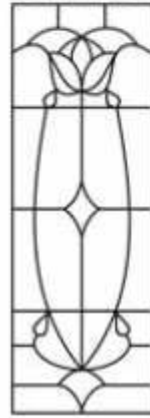

CRD027

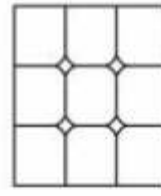

CRD028

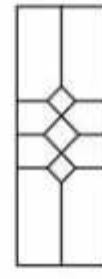

CRD029



CRD030

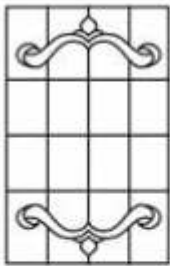

CRD031



CRD032



CRD033



CRD034



CRD035

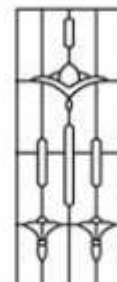

CRD036

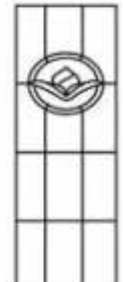

CRD037

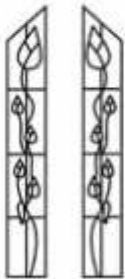

CRD038



CRD039



CRD040



CRD041

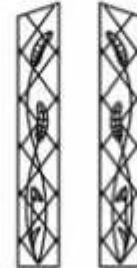

CRD042

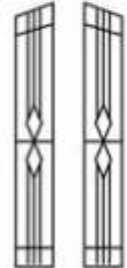

CRD043



ERTEK CAM-VİTRAY

Vinç-Çerçeve-Ayna-Vantus-Cam Çeşitleri-Vitrav Uygulama

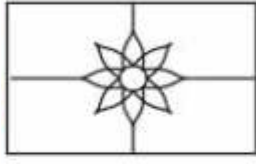

CRD061

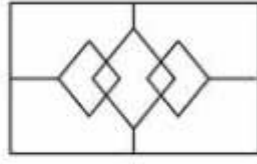

CRD062

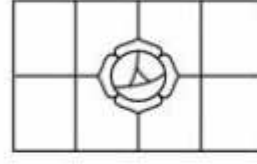

CRD063

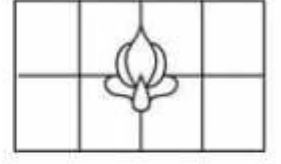

CRD064

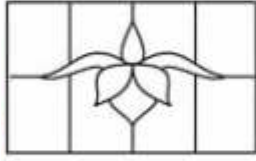

CRD065

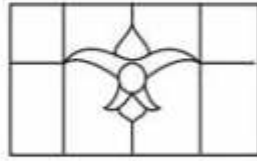

CRD066

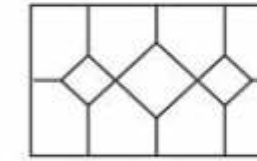

CRD067

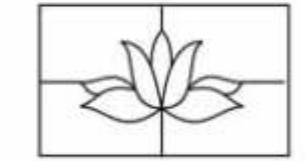

CRD068

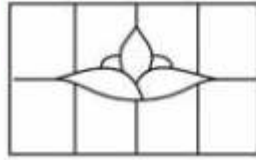

CRD069

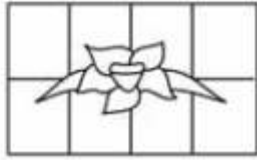

CRD070

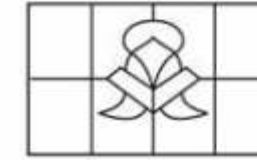

CRD071



CRD072

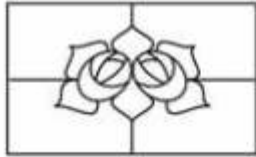

CRD073



CRD074

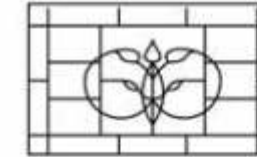

CRD075

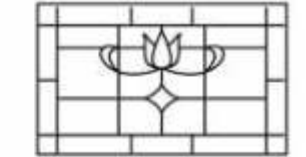

CRD076

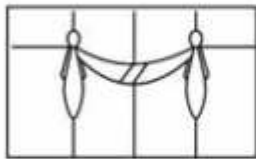

CRD077

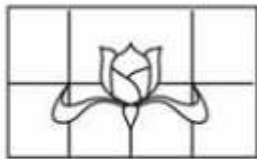

CRD078

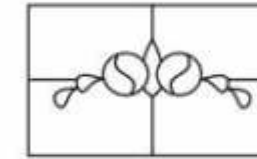

CRD079

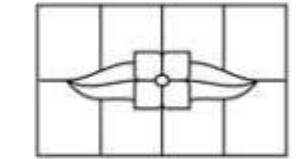

CRD080

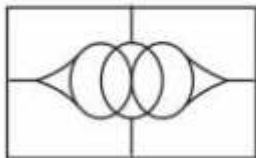

CRD081

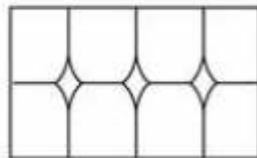

CRD082

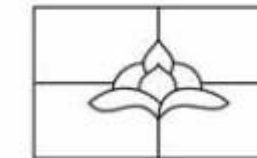

CRD083

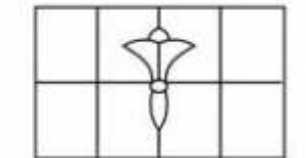

CRD084



ERTEK CAM-VİTRAY

Vinc-Çerçeve-Ayna-Vantus-Cam Çeşitleri-Vitray Uygulama



D-27



D-28

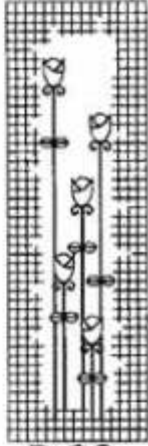

D-29



D-30



D-31



D-32

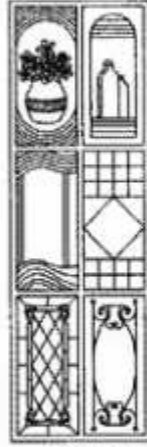

D-33



D-34



ERTEK CAM-VİTRAY

Vinc-Çerçeve-Ayna-Vantus-Cam Çeşitleri-Vitrav Uygulama



CRD207



CRD208

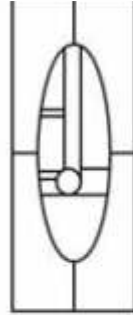

CRD209



CRD210



CRD211

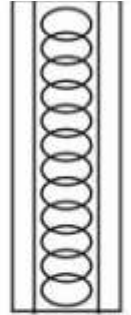

CRD212



CRD213

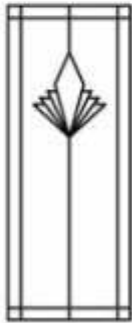

CRD214

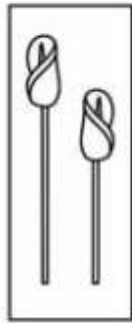

CRD215

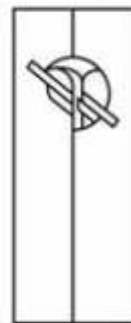

CRD216

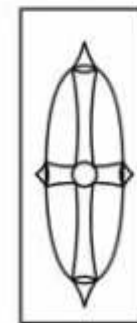

CRD217

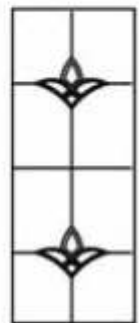

CRD218

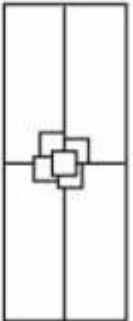

CRD219



CRD220

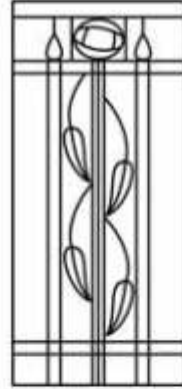

CRD221

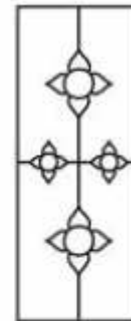

CRD222



CRD223



CRD224

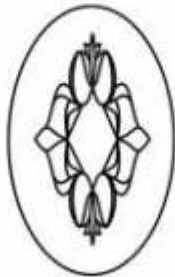

CRD225



CRD226



CRD227



CRD228

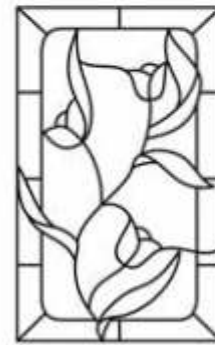

CRD229

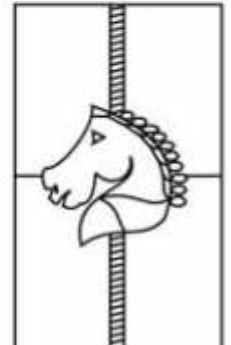

CRD230



ERTEK CAM-VİTRAY

Vinc-Çerçeve-Ayna-Vantus-Cam Çeşitleri-Vitrav Uygulama

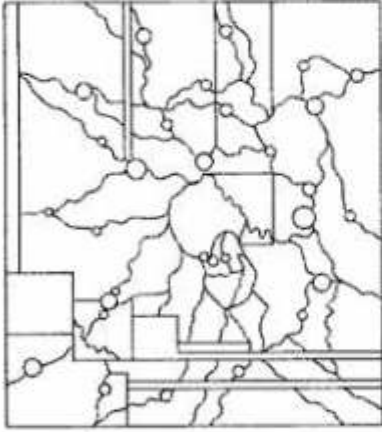

RESIN01

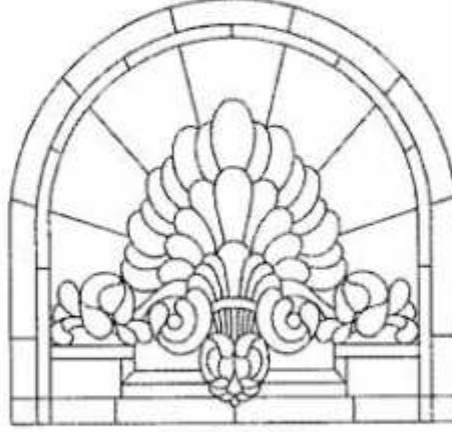

RESIN02

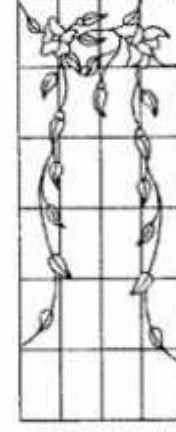

RESIN03

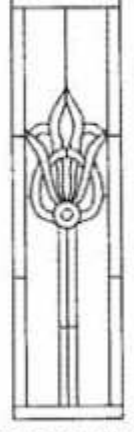

RESIN04

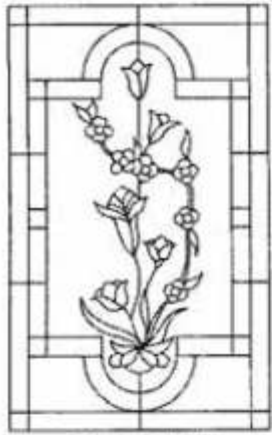

RESIN05

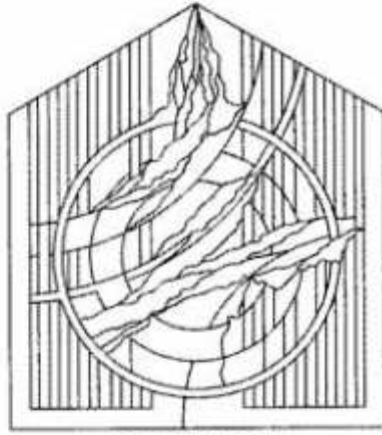

RESIN06



RESIN07



RESIN08



RESIN09

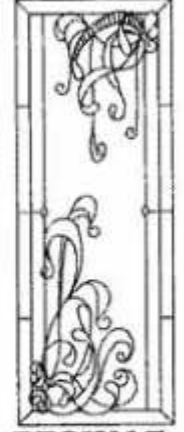
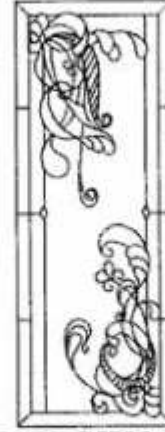
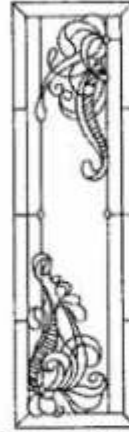

RESIN10 RESIN11 RESIN12 RESIN13 RESIN14 RESIN15 RESIN16 RESIN17



ERTEK CAM-VİTRAY

Vinç-Çerçeve-Ayna-Vantus-Cam Çeşitleri-Vitray Uygulama

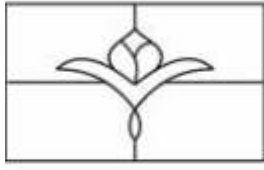

CRD085

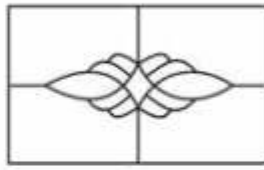

CRD086

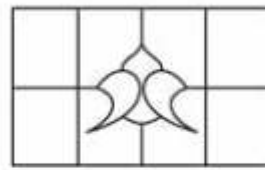

CRD087

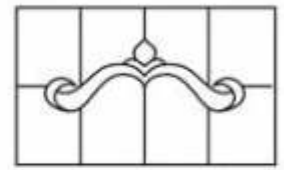

CRD088

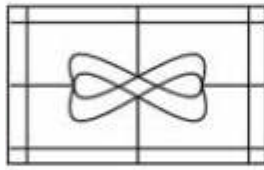

CRD089



CRD090

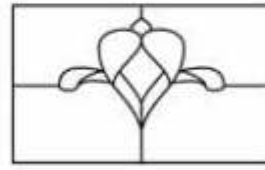

CRD091



CRD092

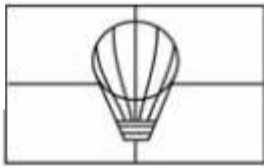

CRD093



CRD094

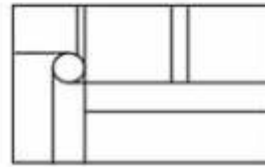

CRD095

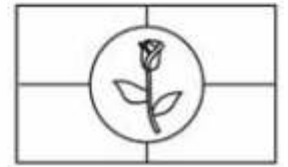

CRD096



CRD097

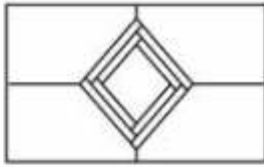

CRD098

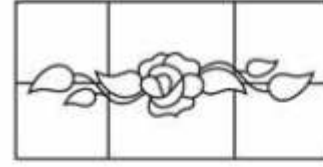

CRD099

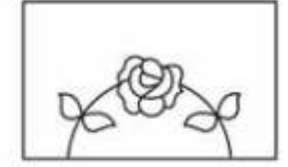

CRD100

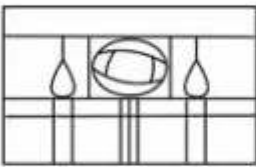

CRD101

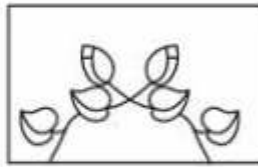

CRD102

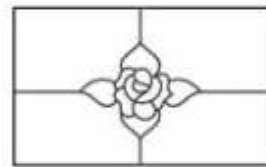

CRD103

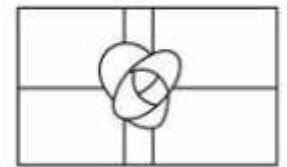

CRD104

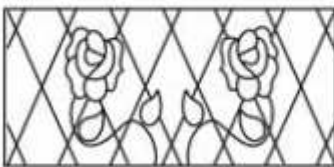

CRD105

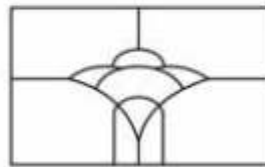

CRD106

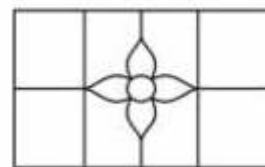

CRD107

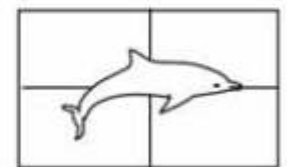

CRD108



ERTEK CAM-VİTRAY

Vinc-Çerçeve-Ayna-Vantus-Cam Çeşitleri-Vitray Uygulama



CRD231

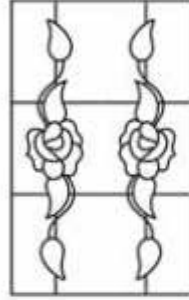

CRD232



CRD233

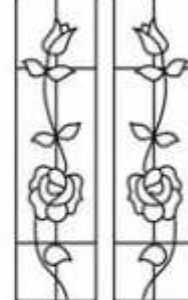

CRD234

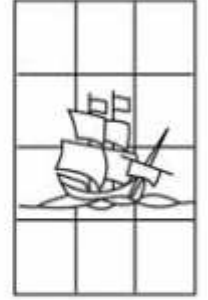

CRD235



CRD236

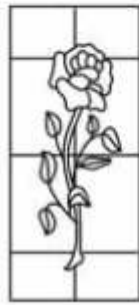

CRD237

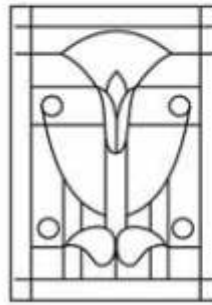

CRD238

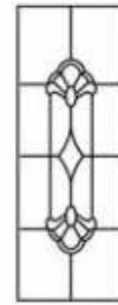

CRD239

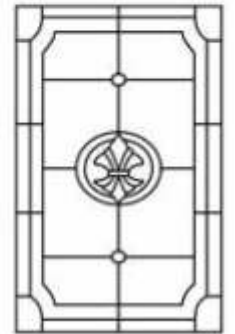

CRD240



CRD241



CRD242



CRD243

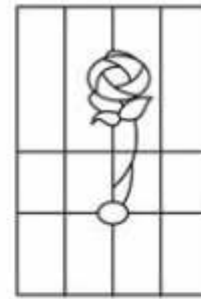

CRD244

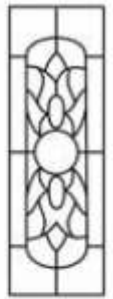

CRD245



CRD246



CRD247

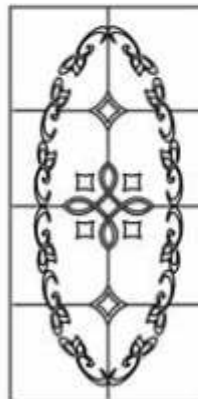

CRD248

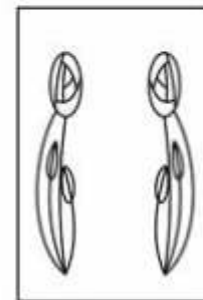

CRD249

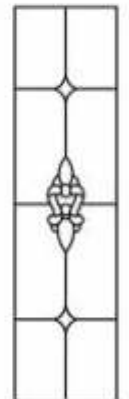

CRD250



ERTEK CAM-VİTRAY

Vinc-Çerçeve-Ayna-Vantus-Cam Çeşitleri-Vitray Uygulama

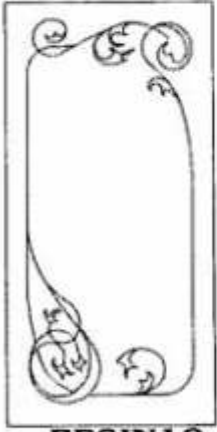

RESIN18

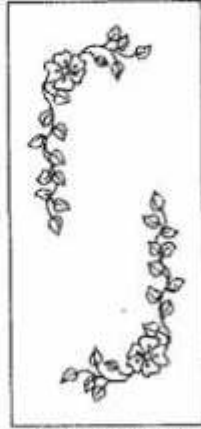

RESIN19



RESIN20

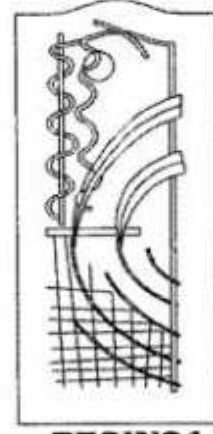

RESIN21

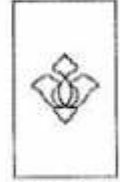

RESIN22

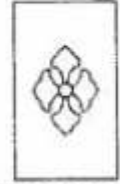

RESIN23



RESIN24



RESIN26

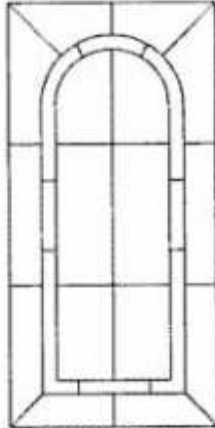

RESIN28

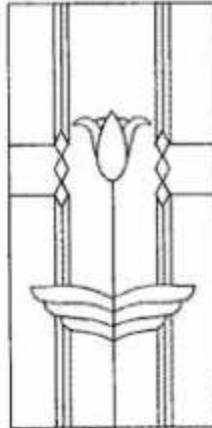

RESIN29

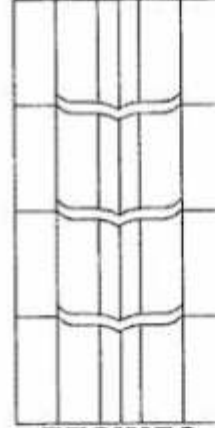

RESIN30

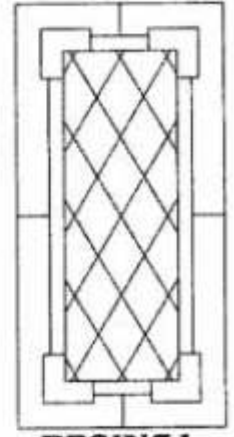

RESIN31



RESIN25



RESIN27



RESIN32

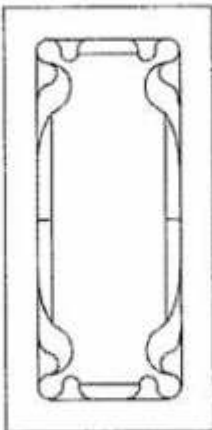

RESIN33

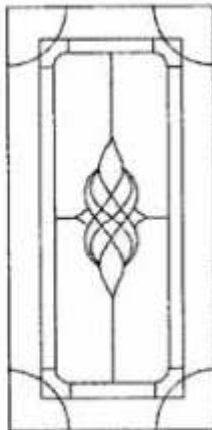

RESIN34

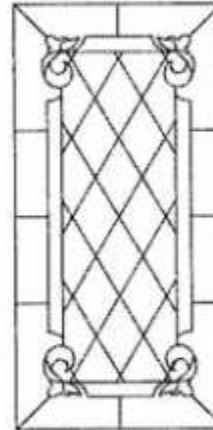

RESIN35



RESIN36

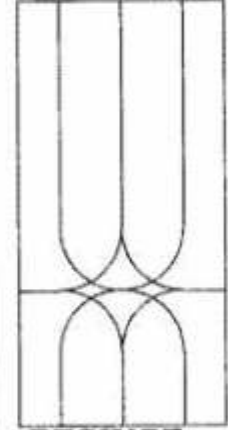

RESIN37



ERTEK CAM-VİTRAY

Vinc-Çerçeve-Ayna-Vantus-Cam Çeşitleri-Vitray Uygulama

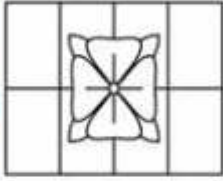

CRD111

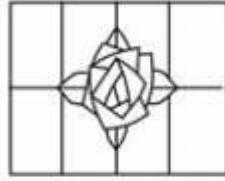

CRD112

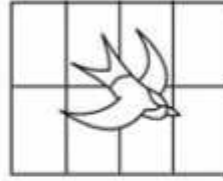

CRD113

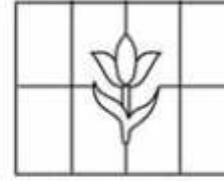

CRD114

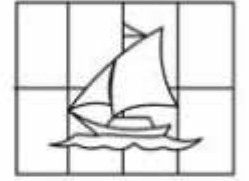

CRD115



CRD116

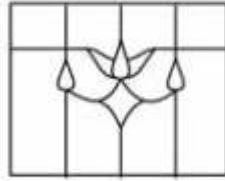

CRD117

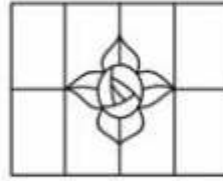

CRD118

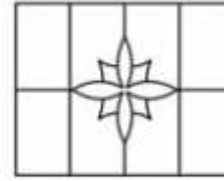

CRD119

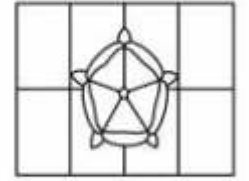

CRD120

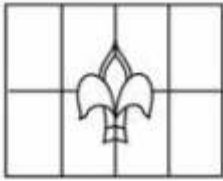

CRD121

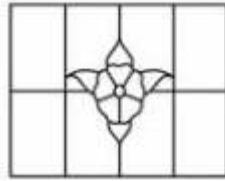

CRD122

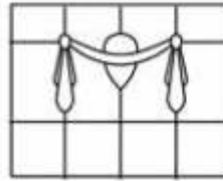

CRD123

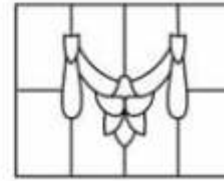

CRD124

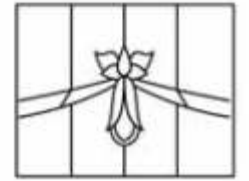

CRD125

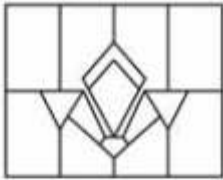

CRD126

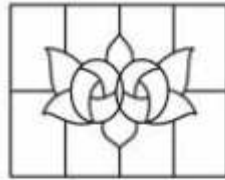

CRD127

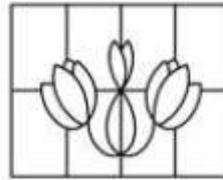

CRD128

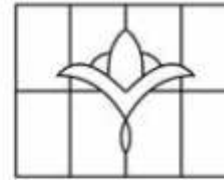

CRD129

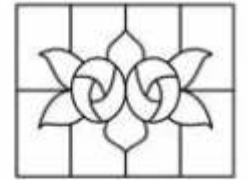

CRD130

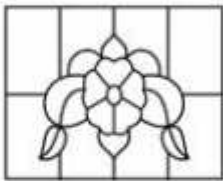

CRD131

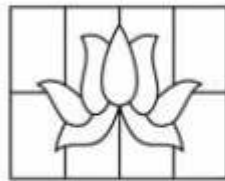

CRD132

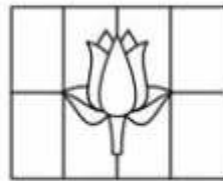

CRD133

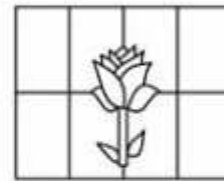

CRD134

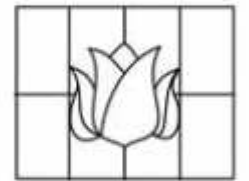

CRD135

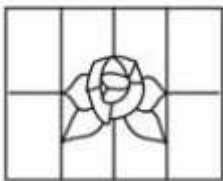

CRD136

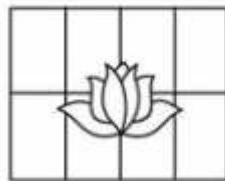

CRD137

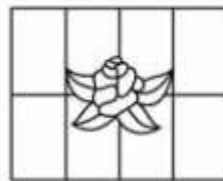

CRD138

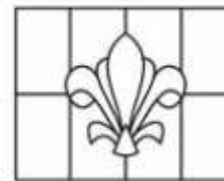

CRD139

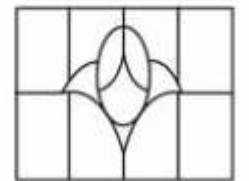

CRD140

www.ertekcam.com



ERTEK CAM-VİTRAY

Vinc-Çerçeve-Ayna-Vantus-Cam Çeşitleri-Vitray Uygulama

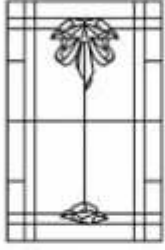

CRD251

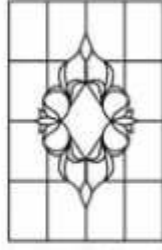

CRD252

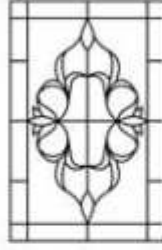

CRD253



CRD254



CRD255



CRD256

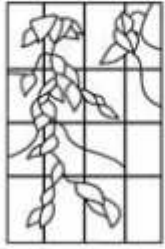

CRD257

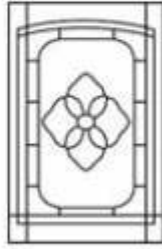

CRD258

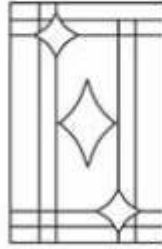

CRD259



CRD260



CRD261

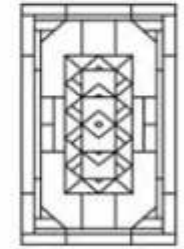

CRD262

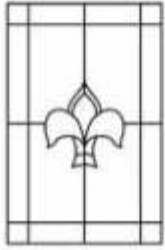

CRD263

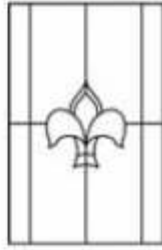

CRD264

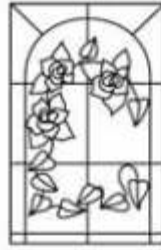

CRD265



CRD266

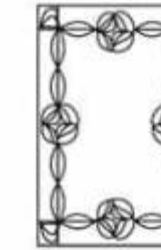

CRD267

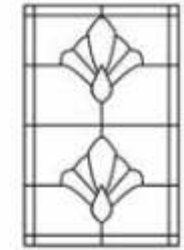

CRD268



CRD269



CRD270



CRD271

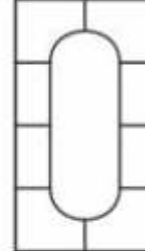

CRD272

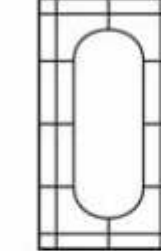

CRD273

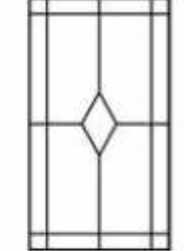

CRD274

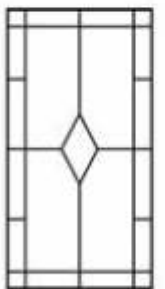

CRD275

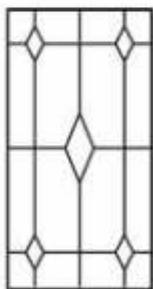

CRD276

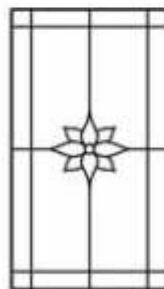

CRD277

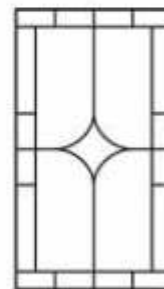

CRD278



CRD279

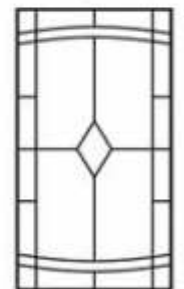

CRD280



ERTEK CAM-VİTRAY

Vinc-Çerçeve-Ayna-Vantus-Cam Çeşitleri-Vitrav Uygulama

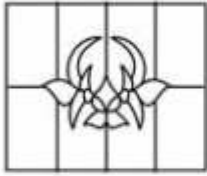

CRD141

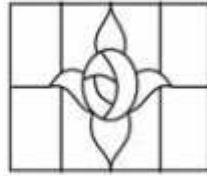

CRD142

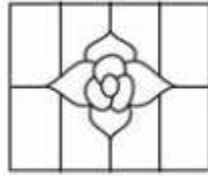

CRD143

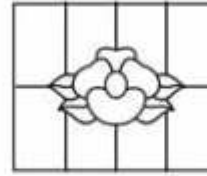

CRD144

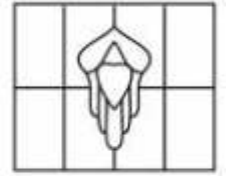

CRD145

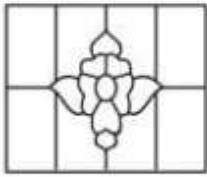

CRD146



CRD147

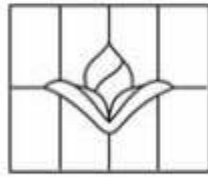

CRD148

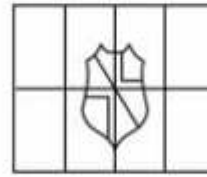

CRD149

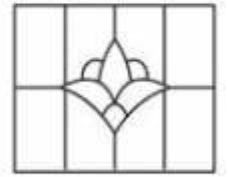

CRD150

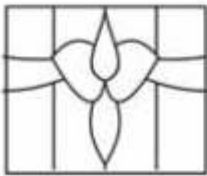

CRD151

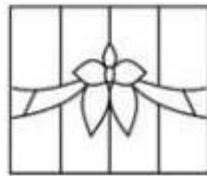

CRD152

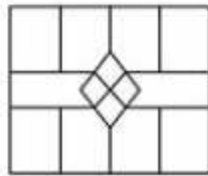

CRD153

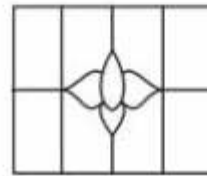

CRD154



CRD155

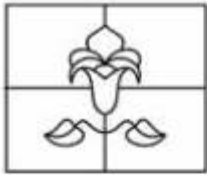

CRD156

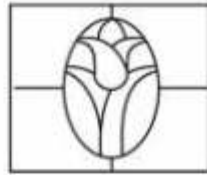

CRD157

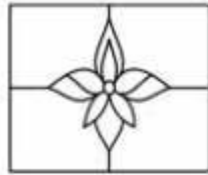

CRD158

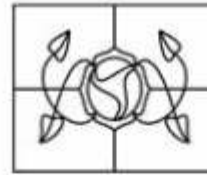

CRD159

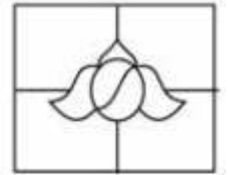

CRD160

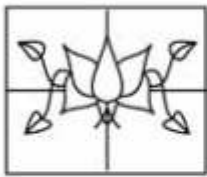

CRD161

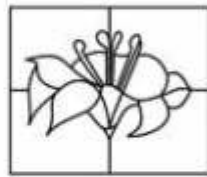

CRD162



CRD163

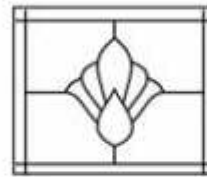

CRD164

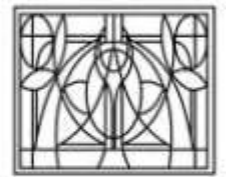

CRD165

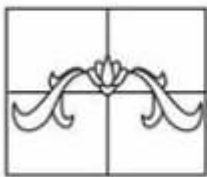

CRD166

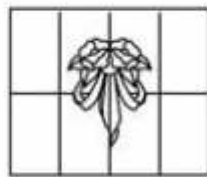

CRD167

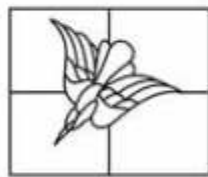

CRD168

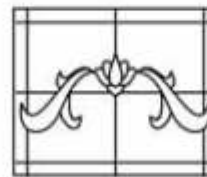

CRD169

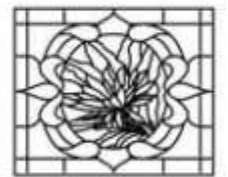

CRD170



ERTEK CAM-VİTRAY

Vinc-Çerçeve-Ayna-Vantus-Cam Çeşitleri-Vitray Uygulama

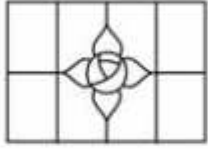

CRD171

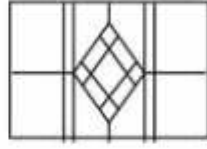

CRD172

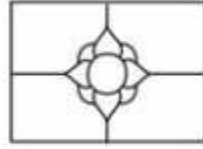

CRD173

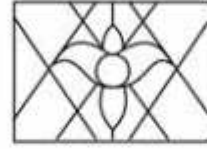

CRD174

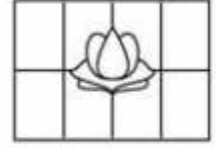

CRD175

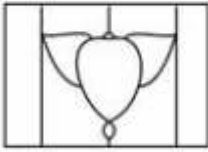

CRD176

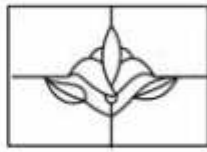

CRD177

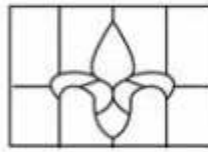

CRD178

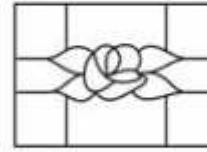

CRD179



CRD180

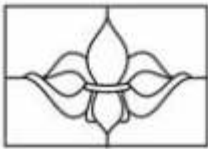

CRD181

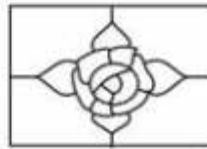

CRD182



CRD183

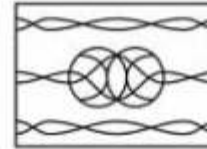

CRD184



CRD185

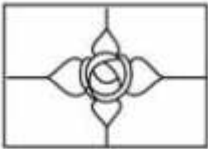

CRD186

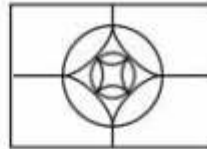

CRD187

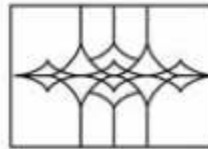

CRD188

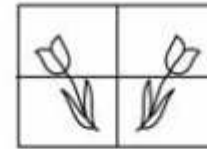

CRD189

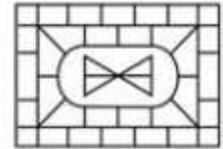

CRD190

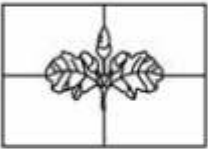

CRD191

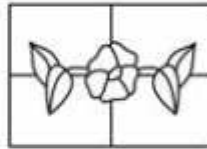

CRD192

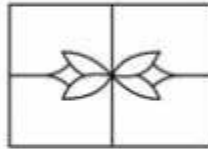

CRD193



CRD194

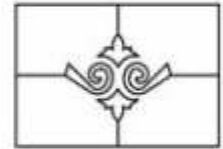

CRD195

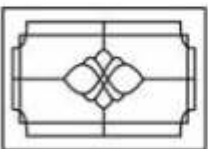

CRD196

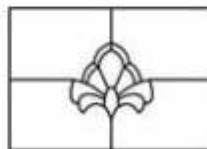

CRD197

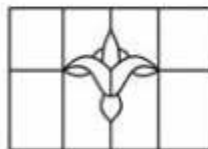

CRD198

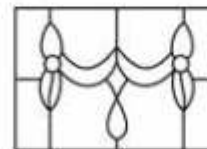

CRD199

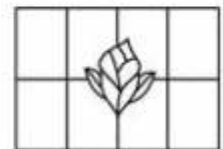

CRD200



ERTEK CAM-VİTRAY

Vinc-Çerçeve-Ayna-Vantus-Cam Çeşitleri-Vitray Uygulama



CRD001

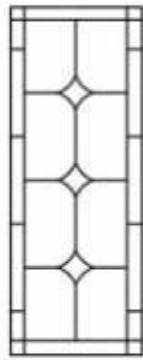

CRD002

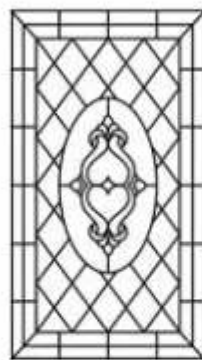

CRD003

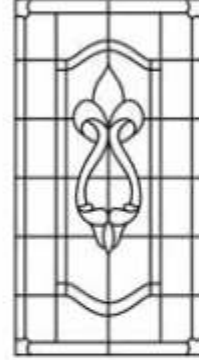

CRD004

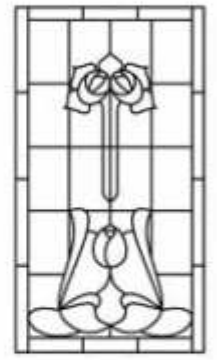

CRD005



CRD006

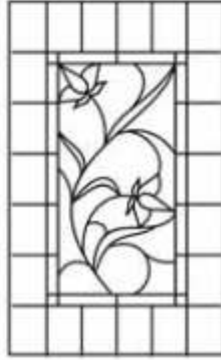

CRD007

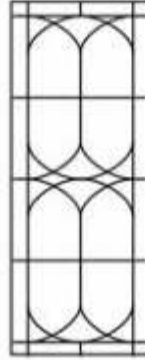

CRD008



CRD009

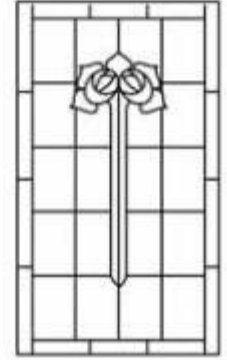

CRD010

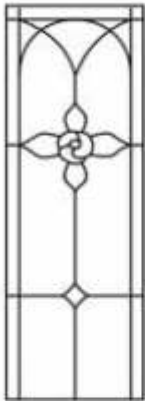

CRD011

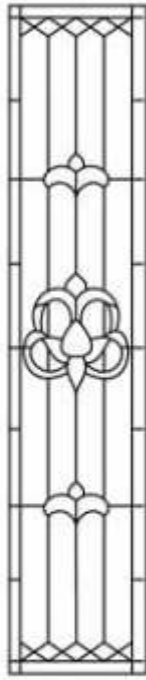

CRD012

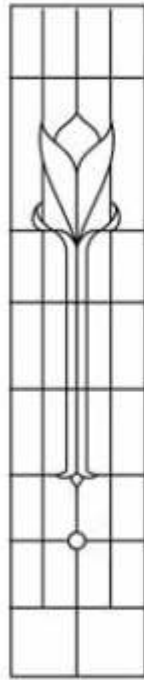

CRD013

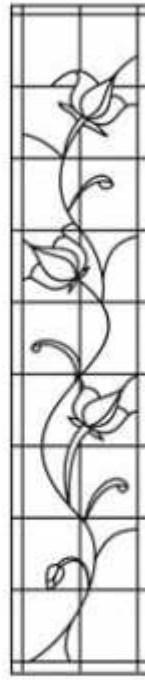

CRD014



CRD015

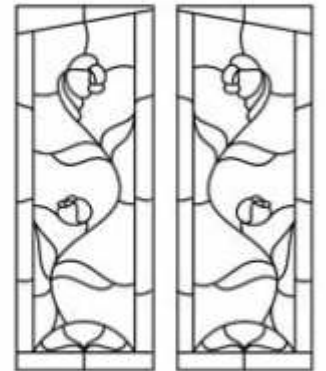

CRD016



ERTEK CAM-VİTRAY

Vinc-Çerçeve-Ayna-Vantus-Cam Çeşitleri-Vitray Uygulama

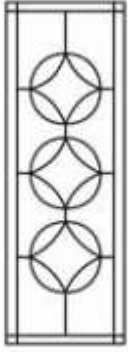

CRD281

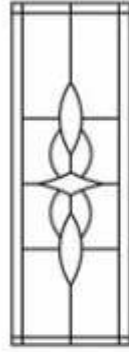

CRD282



CRD283



CRD284

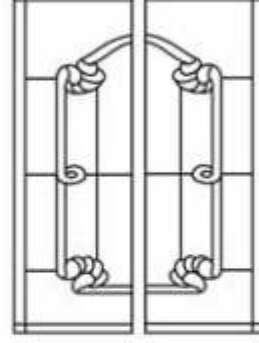

CRD285



CRD286

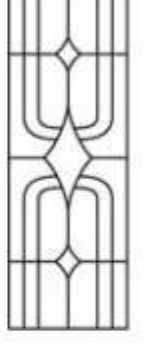

CRD287

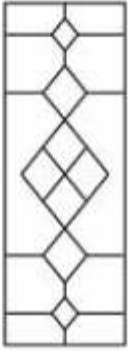

CRD288



CRD289

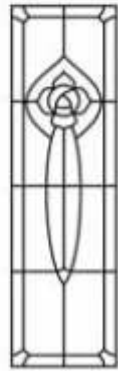

CRD290



CRD291



CRD292

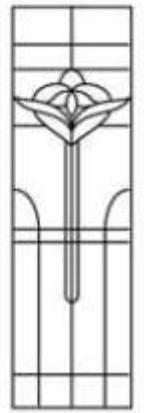

CRD293



CRD294



CRD295

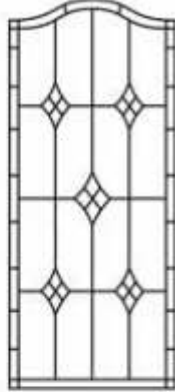

CRD296

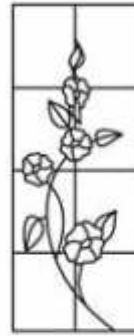

CRD297



CRD298



CRD299

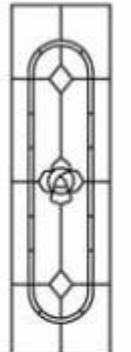

CRD300



CRD301



CRD302

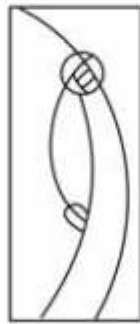

CRD303



CRD304

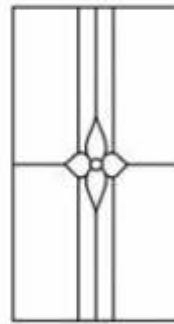

CRD305

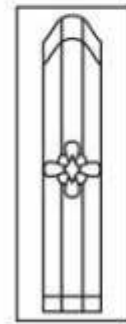

CRD306

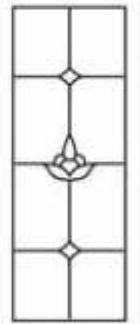

CRD307



ERTEK CAM-VİTRAY

Vinc-Çerçeve-Ayna-Vantus-Cam Çeşitleri-Vitrav Uygulama



CRD401



CRD402



CRD403

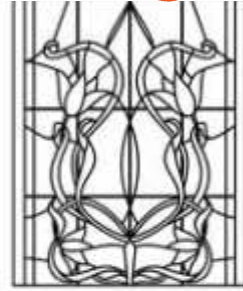

CRD404

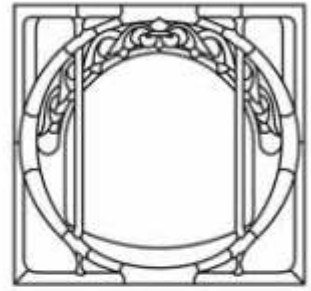

CRD405

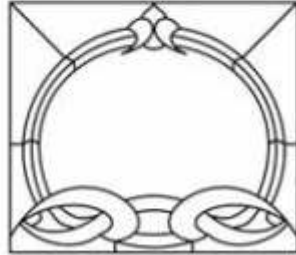

CRD406

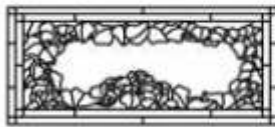

CRD407

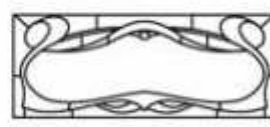

CRD408

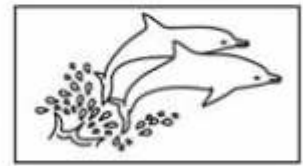

CRD409



CRD410



CRD411



CRD412



CRD413

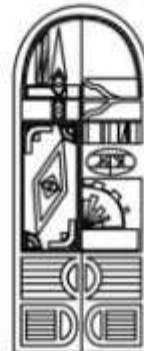

CRD414

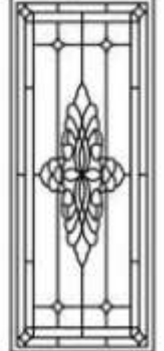

CRD415

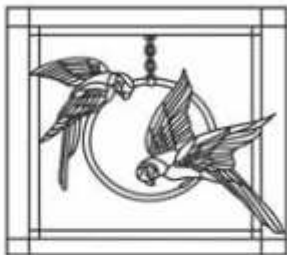

CRD416

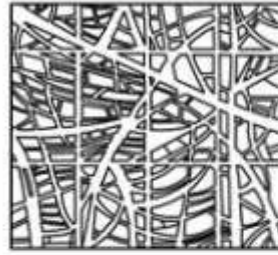

CRD417

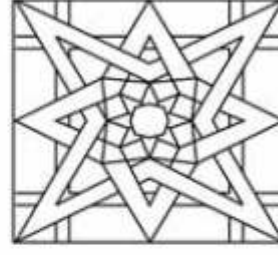

CRD418



CRD419



CRD420

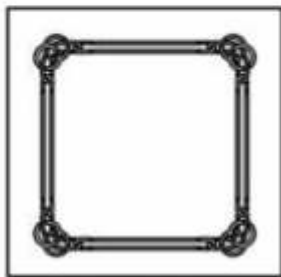

CRD421



CRD422

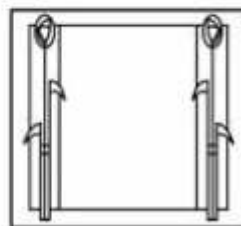

CRD423



CRD424

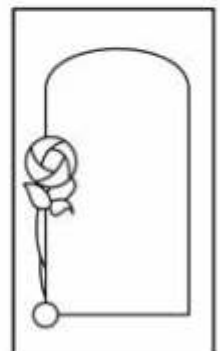

CRD425



ERTEK CAM-VİTRAY

Vinc-Çerçeve-Ayna-Vantus-Cam Çeşitleri-Vitray Uygulama

CRİ-1



CRİ-6



CRİ-11



CRİ-16

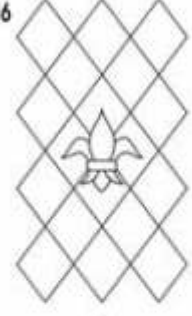

CRİ-2



CRİ-7

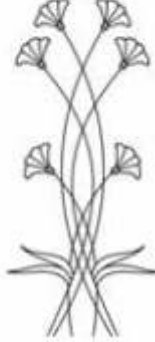

CRİ-12



CRİ-17

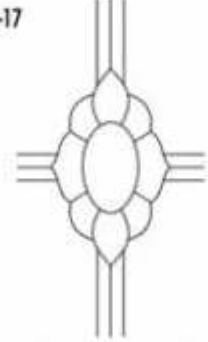

CRİ-3



CRİ-8



CRİ-13



CRİ-18

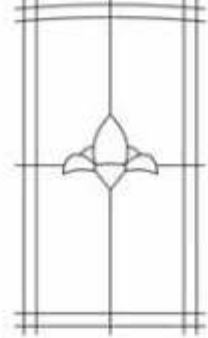

CRİ-4



CRİ-9



CRİ-14



CRİ-19

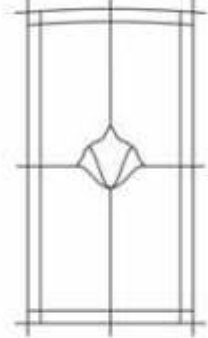

CRİ-5

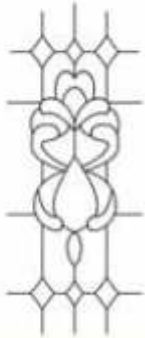

CRİ-10

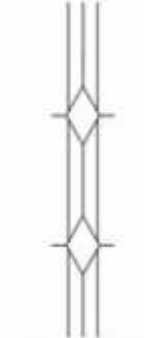

CRİ-15



CRİ-20

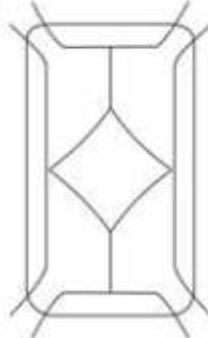



ERTEK CAM-VİTRAY

Vinc-Çerçeve-Ayna-Vantus-Cam Çeşitleri-Vitray Uygulama

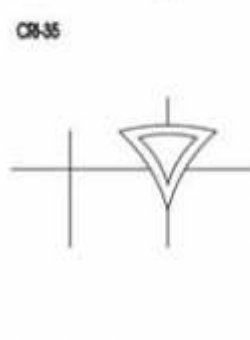
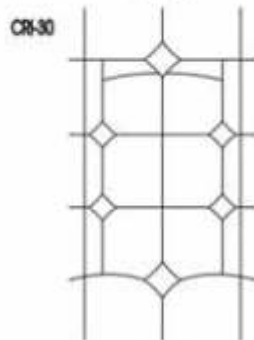
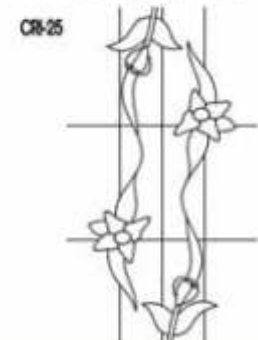
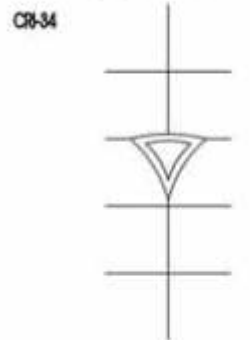
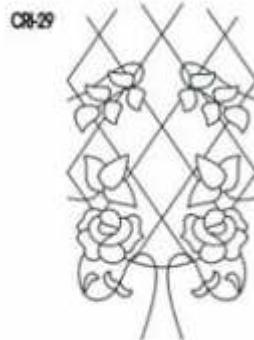
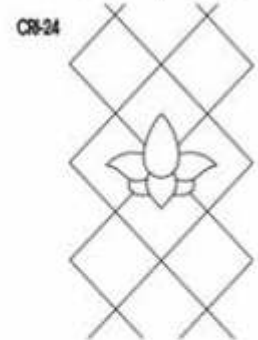
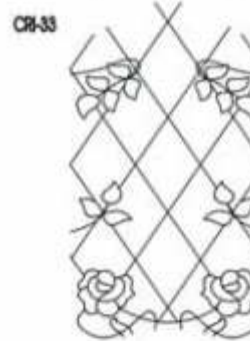
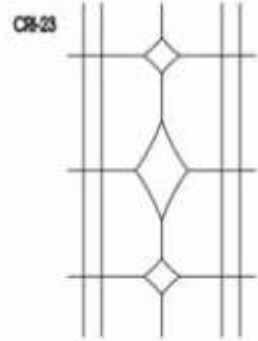
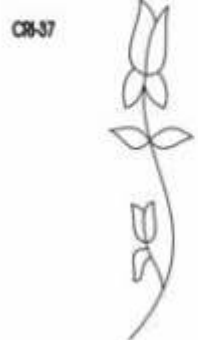
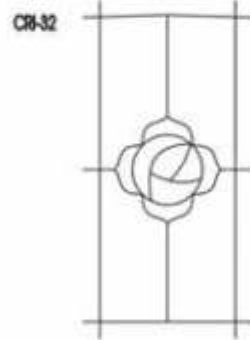
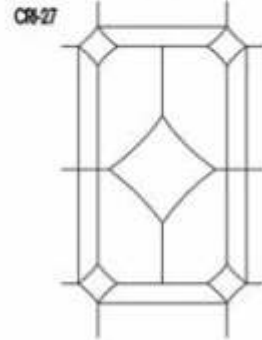
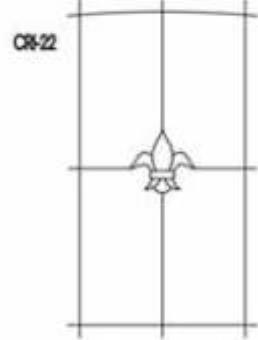
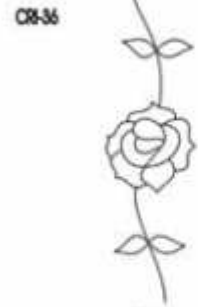
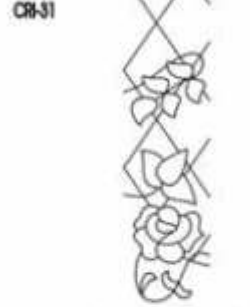
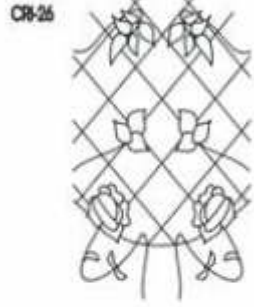
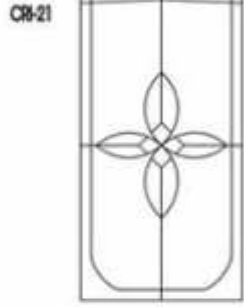



ERTEK CAM-VİTRAY

Vinc-Çerçeve-Ayna-Vantus-Cam Çeşitleri-Vitray Uygulama

CRI-41

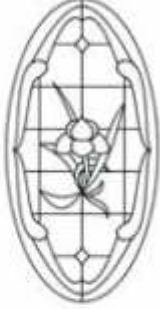

CRI-46

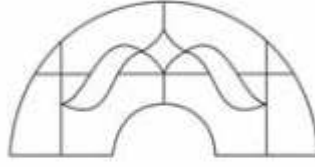

CRI-51



CRI-56



CRI-42

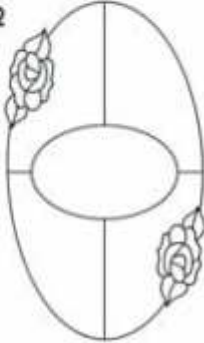

CRI-47



CRI-52



CRI-57



CRI-43

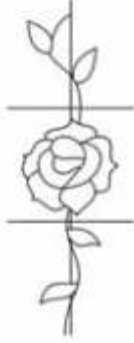

CRI-48



CRI-53



CRI-58



CRI-44

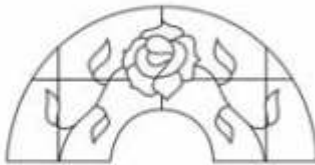

CRI-49

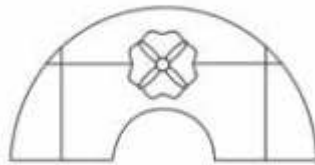

CRI-54

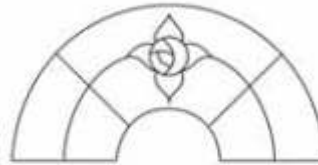

CRI-59



CRI-45

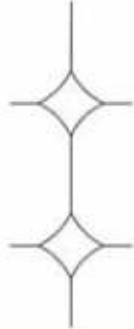

CRI-50

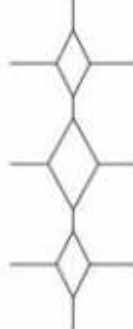

CRI-55



CRI-60

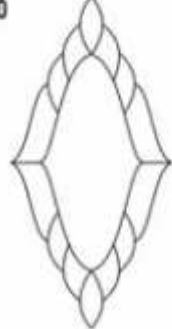



ERTEK CAM-VİTRAY

Vinc-Çerçeve-Ayna-Vantus-Cam Çeşitleri-Vitray Uygulama

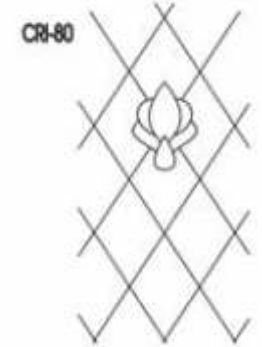
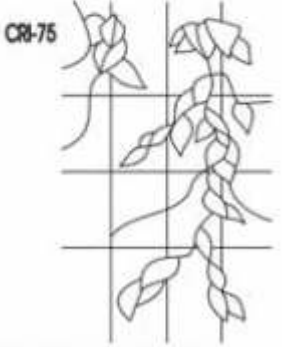
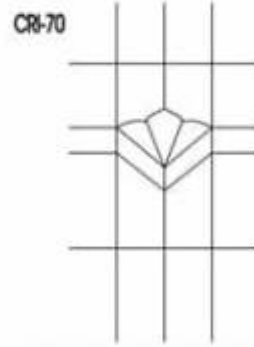
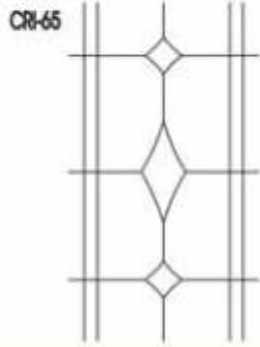
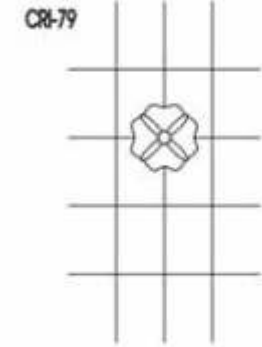
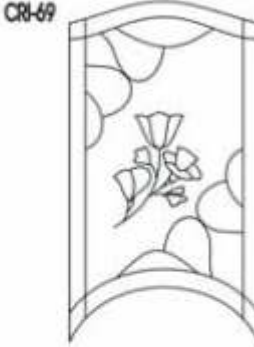
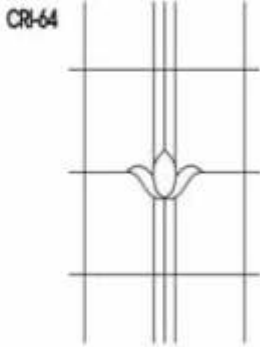
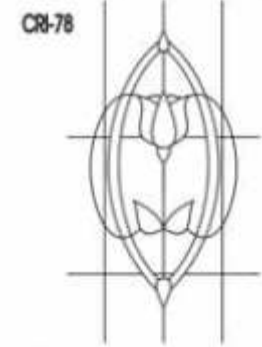
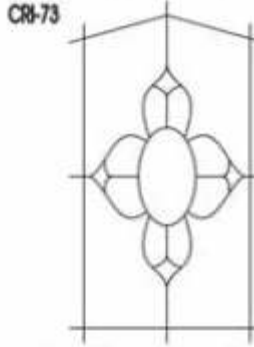
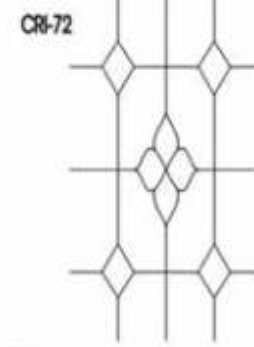
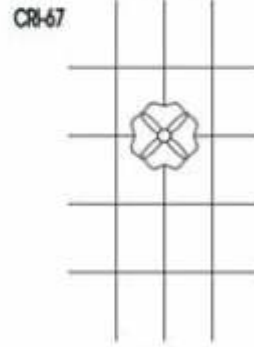
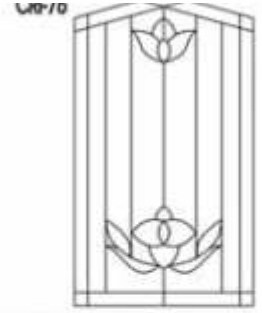
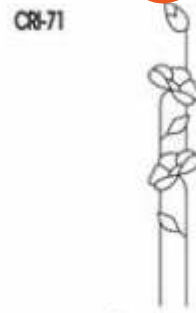
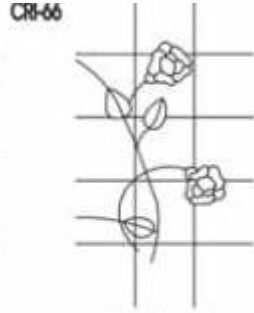
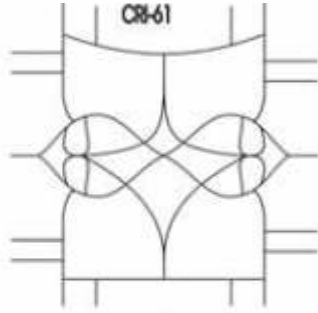



ERTEK CAM-VİTRAY

Vinç-Çerçeve-Ayna-Vantus-Cam Çeşitleri-Vitray Uygulama

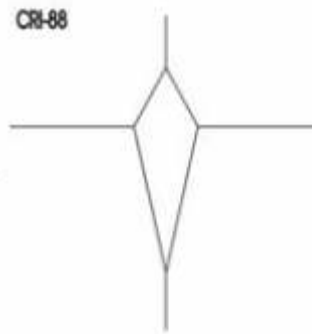
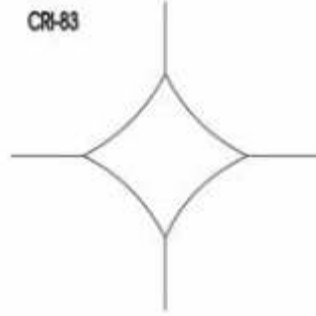
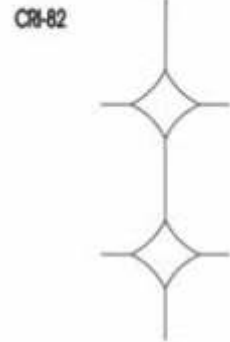



ERTEK CAM-VİTRAY

Vinç-Çerçeve-Ayna-Vantus-Cam Çeşitleri-Vitray Uygulama

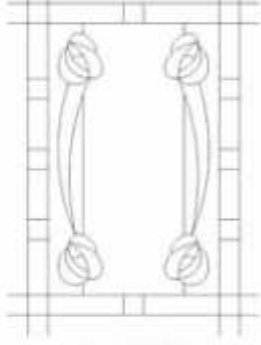

CRI 91

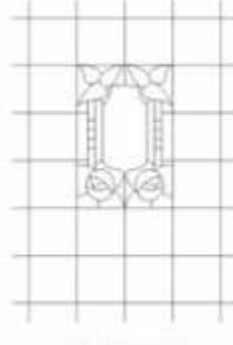

CRI 92

CRI 93

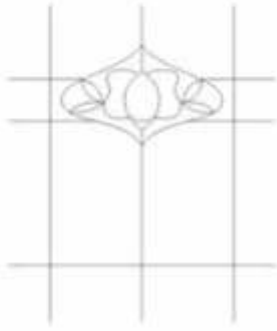

CRI 94



CRI 95

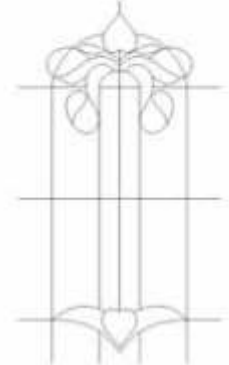

CRI 96

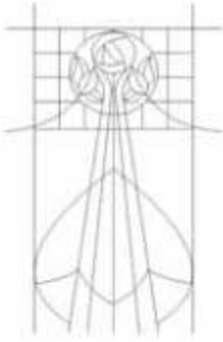

CRI 97

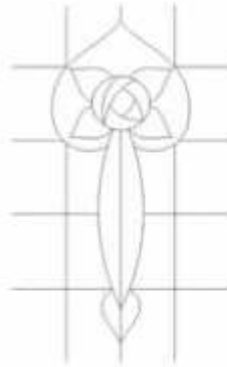

CRI 98



CRI 99



CRI 100



CRI 101



CRI 102



ERTEK CAM-VİTRAY

Vinç-Çerçeve-Ayna-Vantus-Cam Çeşitleri-Vitray Uygulama



CRI 103



CRI 104

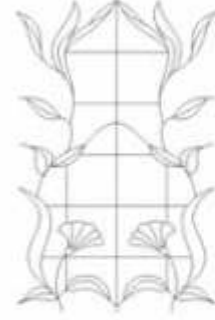

CRI 105

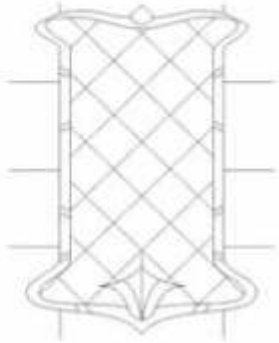

CRI 106

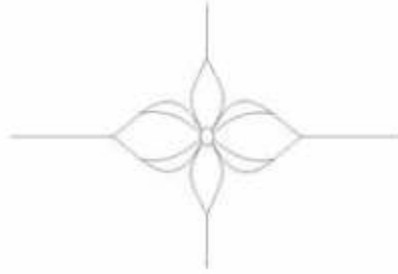

CRI 107



CRI 108

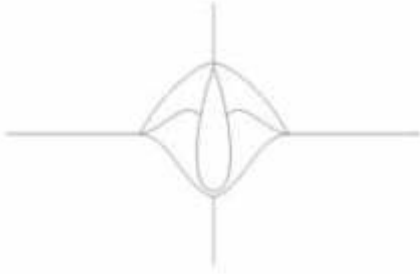

CRI 109

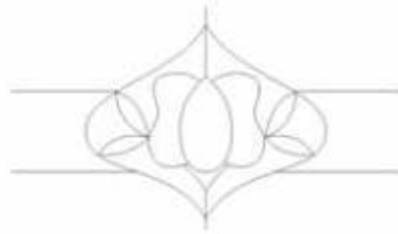

CRI 110

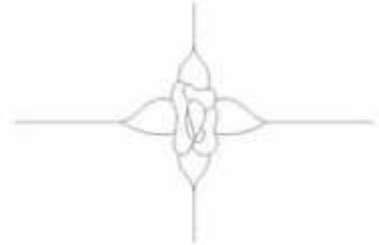

CRI 111

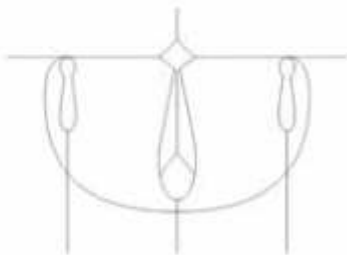

CRI 112



CRI 113

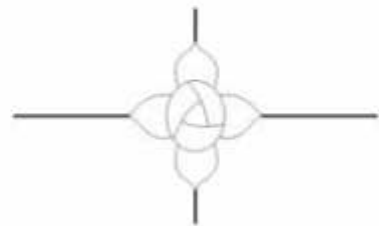

CRI 114



ERTEK CAM-VİTRAY

Vinç-Çerçeve-Ayna-Vantus-Cam Çeşitleri-Vitray Uygulama



CRI 115



CRI 116

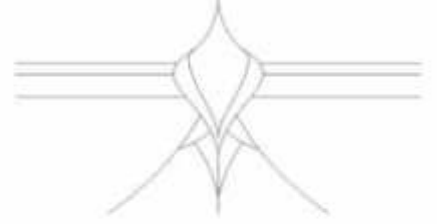

CRI 117



CRI 118



CRI 119



CRI 120



CRI 121

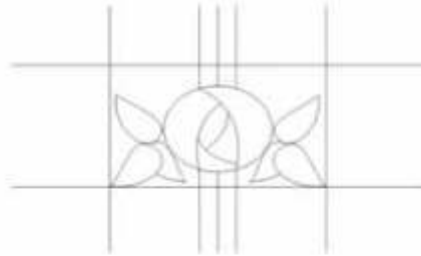

CRI 122



CRI 123

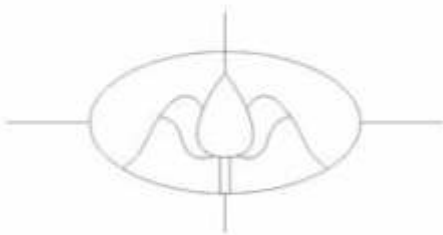

CRI 124



CRI 125



CRI 126



ERTEK CAM-VİTRAY

Vinc-Çerçeve-Ayna-Vantus-Cam Çeşitleri-Vitray Uygulama

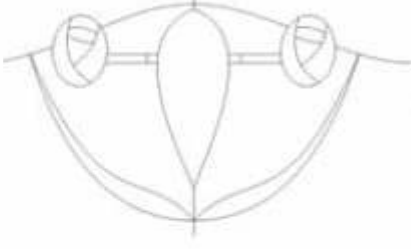

CRI 139



CRI 140



CRI 141

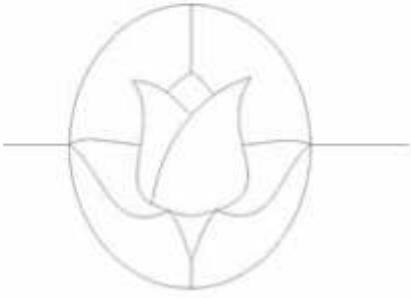

CRI 142



CRI 143



CRI 144

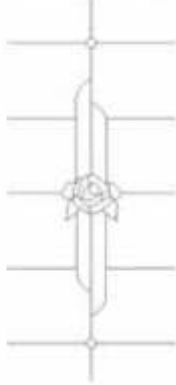

CRI 145



CRI 146

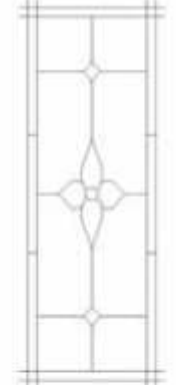

CRI 147

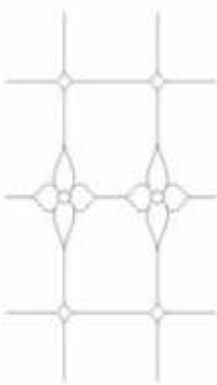

CRI 148



CRI 149



CRI 150



ERTEK CAM-VİTRAY

Vinc-Çerçeve-Ayna-Vantus-Cam Çeşitleri-Vitray Uygulama

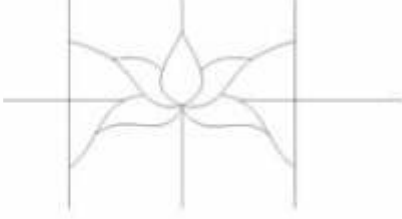

CRI 127



CRI 128

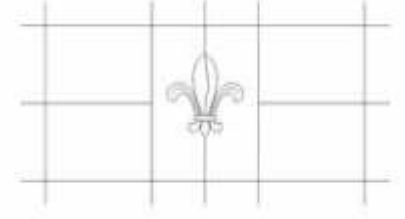

CRI 129

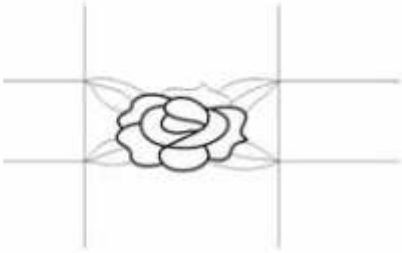

CRI 130



CRI 131

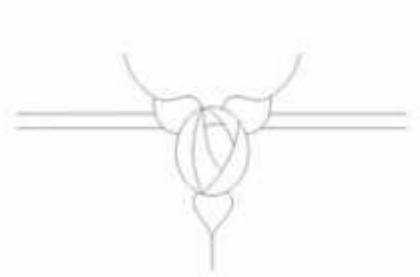

CRI 132

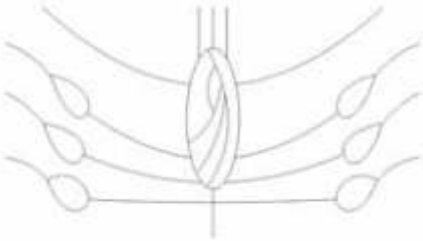

CRI 133



CRI 134



CRI 135

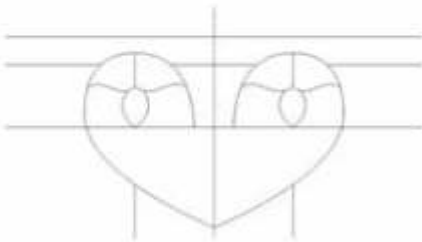

CRI 136

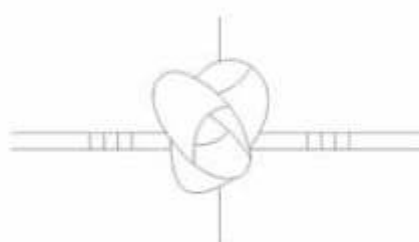

CRI 137

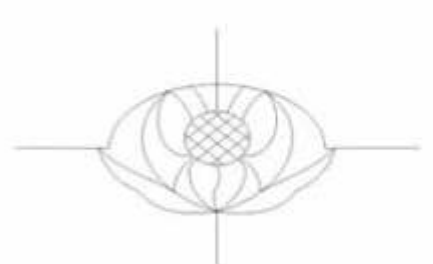

CRI 138



ERTEK CAM-VİTRAY

Vinç-Çerçeve-Ayna-Vantus-Cam Çeşitleri-Vitray Uygulama



CRI 151

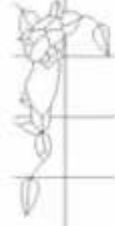

CRI 152

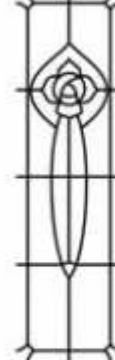

CRI 153

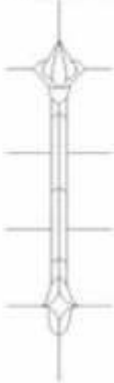

CRI 154

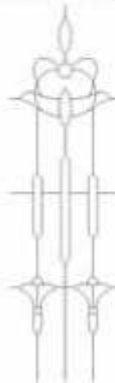

CRI 155

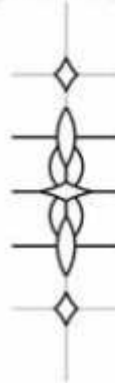

CRI 156



CRI 157



CRI 158



CRI 159

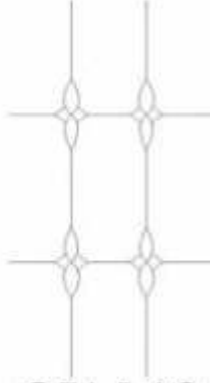

CRI 160

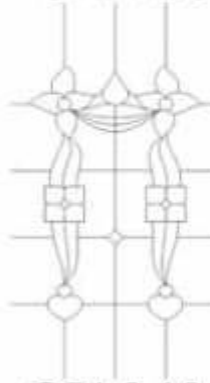

CRI 161



CRI 162



ERTEK CAM-VİTRAY

Vinc-Çerçeve-Ayna-Vantus-Cam Çeşitleri-Vitray Uygulama



CRI 163



CRI 164

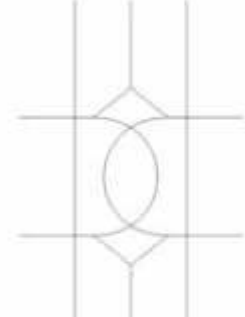

CRI 165



CRI 166



CRI 167



CRI 168



CRI 169



CRI 170



CRI 171

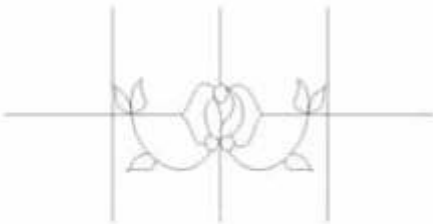

CRI 172



CRI 173



CRI 174

Ertek Cam olarak Cam uygulamalarımızın yanı sıra dekoratif anlamda da **özel tasarım cam** işlememiz bulunmaktadır.

Cam işleme merkezi olarak firmamız **yurt dışından getirdiği özel cam boyaları** sayesinde **Flexi Vitray** tekniği ile dekoratif anlamda mekânınıza değer katıyor. Firmanızın logosu, maskotu veya sizin için hazırladığımız özel tasarımlar sayesinde camda uygulayacağımız bu sistem mekânınıza **canlılık ve farklılık** katacaktır.

Flexi vitray sistemi (**tamamen el işçiliği**) cam boyama ile **camın kullanıldığı her alanda** (Dış cephelerde, iç dekorlarda, panolarda, tabloları, mutfak tezgâh aralarında, barlarda, katlanır camlarda, ısıcamlarda, sehpalarda, ara bölmelerde duvar panellerinde, tavan dekorlarında, ışıklandırma sistemlerinde, aynalarda vs...) istediğiniz desen ya da figürü camın üzerine işlemekteyiz. Camdan ziyade **ahşap** (mdf, suntalem vs) malzemeler üzerine de benzer uygulama yapılmaktadır. Görsel olarak birebir cam etkisinin yanında tamamen **saydam** bir görüntü elde edilebilir. Boyama sistemine göre de **opaklaştırılabilir**. Ayrıca **renklerin canlılığıyla** görsel olarak tatmin edici bir görüntü sağlanır. Minimum **10 yıl garanti** süresi ve **akma, düşme veya solma** gibi sorunlar olmamaktadır.

Tasarım ekibimiz ile mekânınıza farklılık katmak adına **özel çalışmalar** hazırlayabilir bunun yanı sıra kendi tasarımcılarınız ile **ortak** hareket ederek istenilen uygulamayı da hazırlayabiliriz.

Flexi vitray sisteminin yanı sıra cam işleme sistemlerimiz ve özel tasarım çalışmalarımız ile daha yaratıcı çözümlerde geliştirebiliriz.

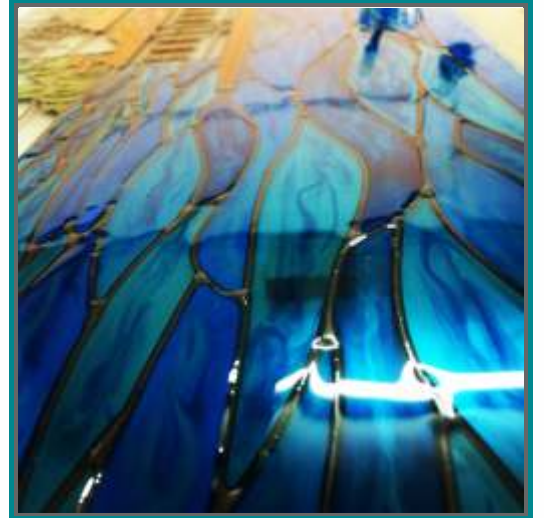

Cam Uygulamalarımız



Baklava Uygulaması

Mutfak Tezgah Arası Dekor Cam Uygulamaları



Efekt Özel Boyama

Mutfak Tezgah Arası Cam Boyama

Lamine Cam Korkuluk ve Merdiven Sistemleri



Kumlama sistemi ile dekor Uygulamaları



ERTEK CAM-VİTRAY

Vinci-Çerçeve-Ayna-Vantus-Cam Çeşitleri-Vitray Uygulama

Cam Uygulamalarımız



ERTEK CAM-VİTRAY

Vinci-Çerçeve-Ayna-Vantus-Cam Çeşitleri-Vitray Uygulama



ERTEK CAM-VİTRAY

Vinç-Çerçeve-Ayna-Vantus-Cam Çeşitleri-Vitray Uygulama

Üçkuyular Mh. 46 sk. No:18/A Karabağlar/ İZMİR

www.ertekcam.com